

Radiant Process Heaters

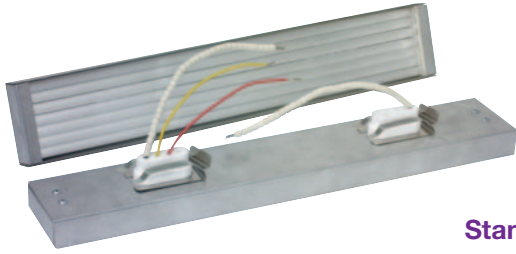

KTE & KTG Series Style C



Series Style C (Ceramic Header with Leads) High Intensity Quartz Mini-Tube Infrared Heaters KTE (Translucent Tubes) & KTG (Clear Tubes with Gold Coated Ceramic Backing)

Standard (Non-Stock) Sizes and Ratings

Heaters listed have ceramic bead insulated leads (single head 3.5", dual head 6"), #8-10 spade terminals, and one-piece spring clips for mounting in 20 or 22 gauge sheet metal.

Wattage	Volts	Drawing	"A" Dim. in mm	"B" Dim. in mm	Translucent Tubes		Gold Coated Ceramic Backing	
					Part Number without Thermocouple	Part Number with Optional Type K Thermocouple	Part Number without Thermocouple	Part Number with Optional Type K Thermocouple
125	220/240	C1 (Single Head)	4.88 123.8	N/A N/A	KTE20015	KTE20016	KTG20011	KTG20012
200	220/240	C1 (Single Head)			KTE20017	KTE20018	KTG20013	KTG20014
250	220/240	C1 (Single Head)			KTE20019	KTE20020	KTG20015	KTG20016
325	220/240	C1 (Single Head)			KTE20021	KTE20022	KTG20017	KTG20018
500	220/240	C1 (Single Head)			KTE20023	KTE20024	KTG20019	KTG20020
185	220/240	C1 (Single Head)	7.31 185.7	N/A N/A	KTE30011	KTE30012	KTG30011	KTG30012
300	220/240	C1 (Single Head)			KTE30013	KTE30014	KTG30013	KTG30014
375	220/240	C1 (Single Head)			KTE30015	KTE30016	KTG30015	KTG30016
500	220/240	C1 (Single Head)			KTE30017	KTE30018	KTG30017	KTG30018
750	220/240	C1 (Single Head)			KTE30019	KTE30020	KTG30019	KTG30020
250	220/240	C1 (Single Head)	9.75 247.7	N/A N/A	KTE10023	KTE10024	KTG10012	KTG10013
400	220/240	C1 (Single Head)			KTE10025	KTE10026	KTG10014	KTG10015
500	220/240	C1 (Single Head)			KTE10027	KTE10028	KTG10016	KTG10017
650	220/240	C1 (Single Head)			KTE10029	KTE10030	KTG10018	KTG10019
1000	220/240	C1 (Single Head)			KTE10031	KTE10032	KTG10020	KTG10021
375	220/240	C1 (Double Head)	14.63 371.5	7.40 188.1	KTE40011	KTE40012	KTG40011	KTG40012
600	220/240	C1 (Double Head)			KTE40013	KTE40014	KTE40013	KTE40014
750	220/240	C1 (Double Head)			KTE40015	KTE40016	KTG40015	KTG40016
1000	220/240	C1 (Double Head)			KTE40017	KTE40018	KTG40017	KTG40018
1500	220/240	C1 (Double Head)			KTE40019	KTE40020	KTG40019	KTG40020
500	220/240	C1 (Double Head)	19.50 495.3	9.88 250.8	KTE50011	KTE50012	—	—
800	220/240	C1 (Double Head)			KTE50013	KTE50014	—	—
1000	220/240	C1 (Double Head)			KTE50015	KTE50016	—	—
1500	220/240	C1 (Double Head)			KTE50017	KTE50018	—	—
2000	220/240	C1 (Double Head)			KTE50019	KTE50020	—	—
250	220/240	C2	See Drawing		KTE60011	KTE60012	KTG60011	KTG60012
400	220/240	C2			KTE60013	KTE60014	KTG60013	KTG60014
500	220/240	C2			KTE60015	KTE60016	KTG60015	KTG60016
650	220/240	C2			KTE60017	KTE60018	KTG60017	KTG60018
1000	220/240	C2			KTE60019	KTE60020	KTG60019	KTG60020

Drawing C1 – Single and Double Head Rectangular Heater

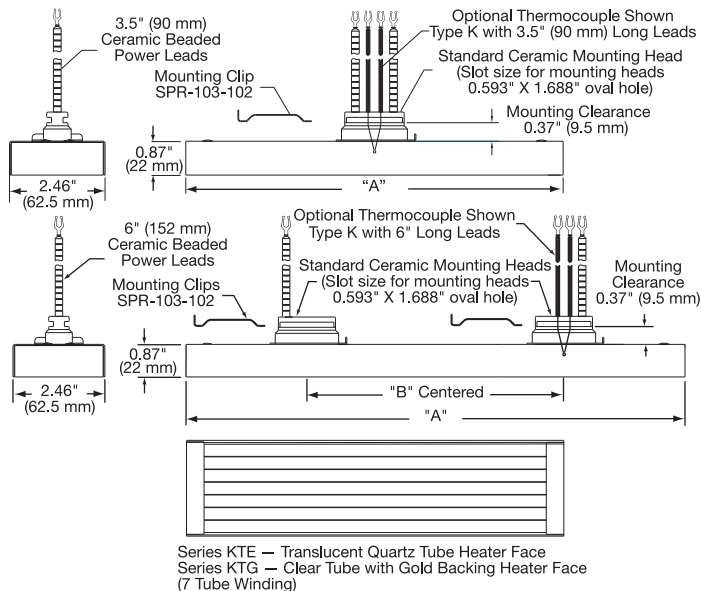

Drawing C2 – Single Head Square Heater

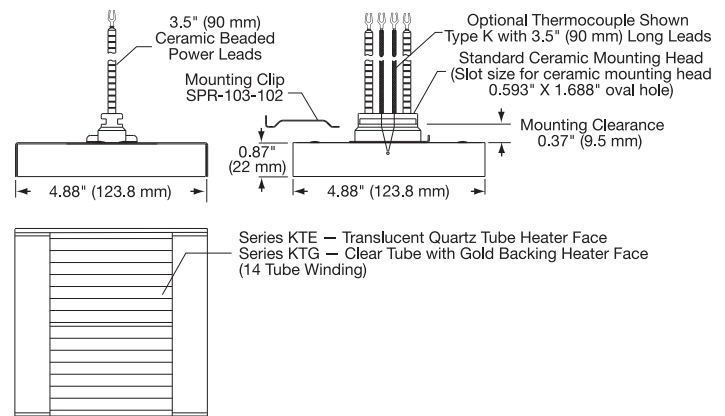



Series Style S (Mounting Studs)
High Intensity Quartz Mini-Tube Infrared Heaters
KTE (Translucent Tubes)
& KTG (Clear Tubes with Gold Coated Ceramic Backing)

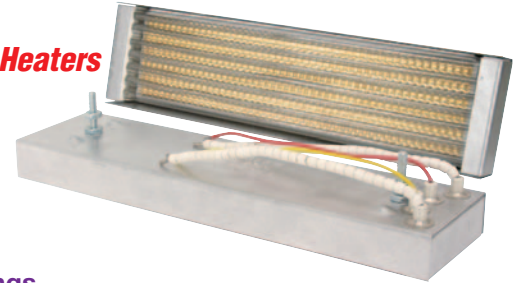

Standard (Non-Stock) Sizes and Ratings

Heaters listed have 6" ceramic bead insulated leads with #8-10 spade terminals.

Wattage	Volts	Drawing	"A" Dim. in mm	"B" Dim. in mm	Translucent Tubes		Gold Coated Part Number without Thermocouple	Ceramic Backing Part Number with Optional Type K Thermocouple
					Part Number without Thermocouple	Part Number with Optional Type K Thermocouple		
125	220/240	S1	4.88 123.8	2.50 63.5	KTE20001	KTE20002	KTG20001	KTG20002
200	220/240	S1			KTE20003	KTE20004	KTG20003	KTG20004
250	220/240	S1			KTE20005	KTE20006	KTG20005	KTG20006
325	220/240	S1			KTE20007	KTE20008	KTG20007	KTG20008
500	220/240	S1			KTE20009	KTE20010	KTG20009	KTG20010
185	220/240	S1	7.31 185.7	4.94 125.4	KTE30001	KTE30002	KTG30001	KTG30002
300	220/240	S1			KTE30003	KTE30004	KTG30003	KTG30004
375	220/240	S1			KTE30005	KTE30006	KTG30005	KTG30006
500	220/240	S1			KTE30007	KTE30008	KTG30007	KTG30008
750	220/240	S1			KTE30009	KTE30010	KTG30009	KTG30010
250	220/240	S1	9.75 247.7	7.38 187.3	KTE10001	KTE10002	KTG10002	KTG10003
400	220/240	S1			KTE10003	KTE10004	KTG10004	KTG10005
500	220/240	S1			KTE10005	KTE10006	KTG10006	KTG10007
650	220/240	S1			KTE10007	KTE10008	KTG10008	KTG10009
1000	220/240	S1			KTE10009	KTE10010	KTG10010	KTG10011
375	220/240	S1	14.63 371.5	12.25 311.2	KTE40001	KTE40002	KTG40001	KTG40002
600	220/240	S1			KTE40003	KTE40004	KTG40003	KTG40004
750	220/240	S1			KTE40005	KTE40006	KTG40005	KTG40006
1000	220/240	S1			KTE40007	KTE40008	KTG40007	KTG40008
1500	220/240	S1			KTE40009	KTE40010	KTG40009	KTG40010
500	220/240	S1	19.50 495.3	17.13 435.0	KTE50001	KTE50002	—	—
800	220/240	S1			KTE50003	KTE50004	—	—
1000	220/240	S1			KTE50005	KTE50006	—	—
1500	220/240	S1			KTE50007	KTE50008	—	—
2000	220/240	S1			KTE50009	KTE50010	—	—
250	220/240	S2	See Drawing		KTE60001	KTE60002	KTG60001	KTG60002
400	220/240	S2			KTE60003	KTE60004	KTG60003	KTG60004
500	220/240	S2			KTE60005	KTE60006	KTG60005	KTG60006
650	220/240	S2			KTE60007	KTE60008	KTG60007	KTG60008
1000	220/240	S2			KTE60009	KTE60010	KTG60009	KTG60010

Drawing S1 – Rectangular Heater

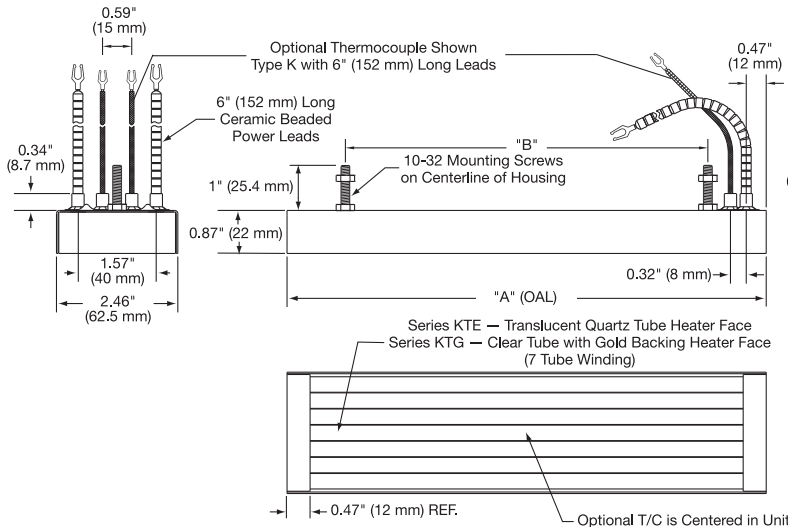

Drawing S2 – Square Heater

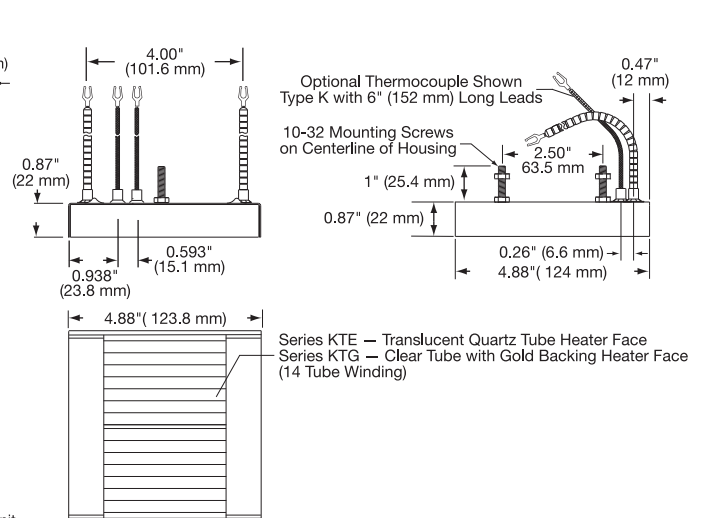

Radiant Process Heaters



KTE Heater Specifications

KTE1 Series – 9.75" × 2.46" Housing

KTE6 Series – 4.88" Square Housing

Watts/Square Inch vs. Temperature Data

Heater Wattage	Heater Face Watt Density*		Heater Body Temp @ 72°F**		Peak Emitted Wavelength*** (microns)	
	Style S	Style C	Style S	Style C	Style S	Style C
	150	8.30	7.12	608	554	4.89
163	9.02	7.73	638	583	4.75	5.00
200	11.07	9.49	714	656	4.44	4.67
250	13.84	11.86	798	740	4.15	4.35
300	16.60	14.23	868	809	3.93	4.11
325	17.99	15.42	898	839	3.84	4.01
350	19.37	16.60	926	868	3.76	3.93
400	22.14	18.98	978	918	3.63	3.78
500	27.67	23.72	1070	1006	3.41	3.56
600	33.20	28.46	1154	1083	3.23	3.38
650	35.97	30.83	1194	1119	3.15	3.30
700	38.74	33.21	1232	1154	3.08	3.23
750	41.51	35.58	1269	1188	3.02	3.16
800	44.27	37.95	1303	1222	2.96	3.10
875	48.42	41.51	1349	1269	2.88	3.02
900	49.81	42.69	1363	1284	2.86	2.99
1000	55.34	47.44	1411	1339	2.79	2.90

KTE2 Series – 4.88" × 2.46" Housing

Watts/Square Inch vs. Temperature Data

Heater Wattage	Heater Face Watt Density*		Heater Body Temp @ 72°F**		Peak Emitted Wavelength*** (microns)	
	Style S	Style C	Style S	Style C	Style S	Style C
	100	12.29	10.53	753	695	4.30
125	15.36	13.16	838	779	4.02	4.21
150	18.43	15.79	907	848	3.82	3.99
163	20.02	17.16	939	880	3.73	3.89
200	24.57	21.05	1020	959	3.52	3.68
250	30.71	26.32	1117	1049	3.31	3.46
300	36.86	31.58	1206	1130	3.13	3.28
325	39.93	34.21	1248	1169	3.05	3.20
350	43.00	36.84	1287	1206	2.99	3.13
400	49.14	42.11	1356	1276	2.87	3.00
500	61.43	52.63	1451	1389	2.73	2.82

KTE3 Series – 7.31" × 2.46" Housing

Watts/Square Inch vs. Temperature Data

Heater Wattage	Heater Face Watt Density*		Heater Body Temp @ 72°F**		Peak Emitted Wavelength*** (microns)	
	Style S	Style C	Style S	Style C	Style S	Style C
	100	7.63	6.54	578	526	5.02
125	9.54	8.18	658	602	4.66	4.91
150	11.45	9.81	726	669	4.40	4.62
163	12.44	10.66	758	700	4.28	4.50
200	15.27	13.08	836	777	4.03	4.22
250	19.08	16.35	921	862	3.78	3.95
300	22.90	19.62	992	931	3.59	3.75
325	24.81	21.26	1024	962	3.51	3.67
350	26.72	22.89	1055	992	3.44	3.59
400	30.53	26.16	1114	1046	3.31	3.46
500	38.17	32.70	1224	1147	3.10	3.25
600	45.80	39.24	1321	1239	2.93	3.07
650	49.62	42.51	1361	1281	2.86	3.00
700	53.44	45.78	1396	1320	2.81	2.93
750	57.25	49.05	1425	1355	2.77	2.87

KTE4 Series – 14.63" × 2.46" Housing

Watts/Square Inch vs. Temperature Data

Heater Wattage	Heater Face Watt Density*		Heater Body Temp @ 72°F**		Peak Emitted Wavelength*** (microns)	
	Style S	Style C	Style S	Style C	Style S	Style C
	200	7.63	6.54	578	526	5.02
250	9.54	8.18	658	602	4.66	4.91
300	11.45	9.81	726	669	4.40	4.62
375	14.31	12.26	811	752	4.10	4.30
400	15.27	13.08	836	777	4.03	4.22
500	19.08	16.35	921	862	3.78	3.95
600	22.90	19.62	992	931	3.59	3.75
750	28.63	24.53	1085	1019	3.38	3.53
800	30.53	26.16	1114	1046	3.31	3.46
900	34.35	29.43	1171	1098	3.20	3.35
1000	38.17	32.70	1224	1147	3.10	3.25
1250	47.71	40.88	1341	1261	2.90	3.03
1500	57.25	49.05	1425	1355	2.77	2.87

KTE5 Series – 19.50" × 2.46" Housing Watts/Square Inch vs. Temperature Data

Heater Wattage	Heater Face Watt Density*		Heater Body Temp @ 72°F**		Peak Emitted Wavelength*** (microns)	
	Style S	Style C	Style S	Style C	Style S	Style C
250	7.16	6.13	556	505	5.14	5.41
300	8.59	7.36	620	565	4.83	5.09
375	10.73	9.20	702	645	4.49	4.72
400	11.45	9.81	726	669	4.40	4.62
500	14.31	12.26	811	752	4.10	4.30
600	17.17	14.71	880	822	3.89	4.07
750	21.47	18.39	966	907	3.66	3.82
800	22.90	19.62	992	931	3.59	3.75
900	25.76	22.07	1040	977	3.48	3.63
1000	28.62	24.52	1085	1019	3.38	3.53
1250	35.78	30.65	1191	1116	3.16	3.31
1500	42.93	36.78	1287	1205	2.99	3.13
1650	47.22	40.46	1336	1255	2.90	3.04
1700	48.65	41.69	1351	1271	2.88	3.01
1750	50.09	42.91	1366	1286	2.86	2.99
1800	51.52	44.14	1379	1301	2.84	2.96
1900	54.38	46.59	1403	1329	2.80	2.92
2000	57.24	49.04	1425	1355	2.77	2.87

*Heater Face Watt Density

Watt density calculation is based on heater face surface area, which is a relative constant value used to relate different sizes of heaters. The 6 tube KTE (Style S) has a surface area 85.7% of a 7 tube unit and will operate at a temperature 16.6% higher than the 7 tube (Style C) unit. This relationship has been confirmed through laboratory testing on various sizes of KTE heaters.

**Heater Body Temp @ 72°F

Heater face temperature as measured with a type K thermocouple mounted directly on the heater face. Temperatures are for a single heater facing down with target re-radiation from an oxidized SS surface 3" from heater face. Operating temperatures (and emitted wavelength) will vary with application conditions such as higher ambient, target absorption properties, moving/stationary systems, and distance to target. The tabulated temperatures are averages compiled from standardized lab tests on different ratings and sizes of KTE heaters. Translucent tube testing showed that various reflector materials and surface conditions (bright, oxidized, etc.) had little or no effect on test results. Lower heater temperatures will occur if radiation is allowed to dissipate freely from the surface without target re-radiation (about 20-25% lower when facing up in open air).

***Peak Emitted Wavelength

Peak infrared radiation wavelength as calculated from Wien's Displacement Law, for the operating temperature shown, expressed in microns (μm). The emissivity of KTE quartz heaters is close to the ideal blackbody value of 1.0 (range is from .88 to .92). This has been confirmed by testing using a thermal infrared camera.

Custom CRA Linear Heater Assemblies for KTE and KTG E-Mitters Using Standard Components

Do It Yourself or let Tempco build an array to your exact specifications.

The CRK Linear Housings assembly (page 7-19) and other components on pages 7-16 through 7-23 for Ceramic E-Mitters are also used with KTE and KTG E-Mitters.

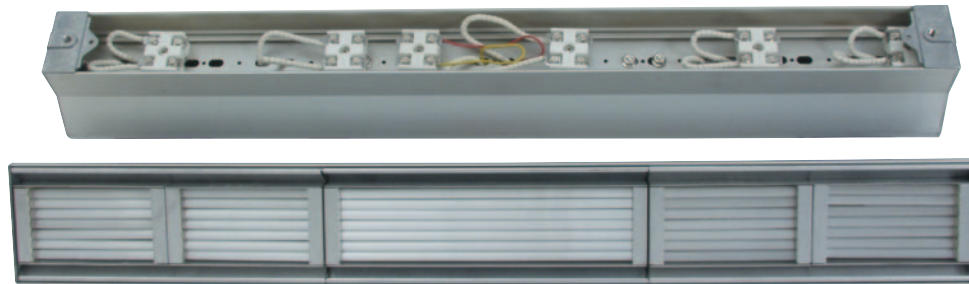

Custom ARV Array Housing Assemblies for KTE and KTG E-Mitters (see pages 7-48 through 7-51)

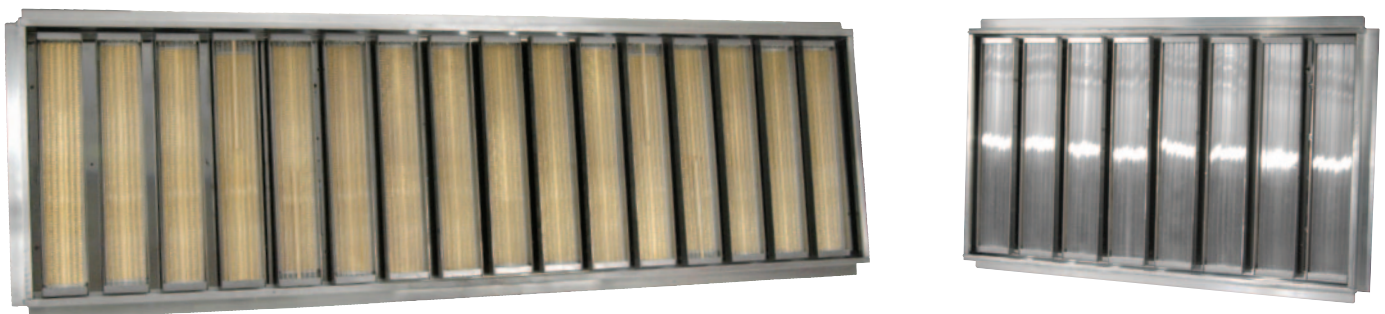

Series KTE1 E-Mitter Panel Arrays Standard Style ARV Structural Housing Dimensions

- A) The Number of Rows will determine the Housing Width. For overall width add 1.50" (for the mounting lips).
B) The Number of Columns will determine the Housing Length. For overall length add 1.50" (for the mounting lips).



Note: Structural Housing Dimensions (width x length) are in inches. For overall dimensions add 0.75" per side for the mounting lip.

Number of Rows	Number of Columns					
	1 W x L	2 W x L	3 W x L	4 W x L	5 W x L	6 W x L
1	4 x 11	4 x 21	4 x 31	4 x 41	4 x 51	4 x 61
1	4 x 11	4 x 21	4 x 31	4 x 41	4 x 51	4 x 61
2	7 x 11	7 x 21	7 x 31	7 x 41	7 x 51	7 x 61
3	10 x 11	10 x 21	10 x 31	10 x 41	10 x 51	10 x 61
4	13 x 11	13 x 21	13 x 31	13 x 41	13 x 51	13 x 61
5	16 x 11	16 x 21	16 x 31	16 x 41	16 x 51	16 x 61
6	19 x 11	19 x 21	19 x 31	19 x 41	19 x 51	19 x 61
7	22 x 11	22 x 21	22 x 31	22 x 41	22 x 51	22 x 61
8	25 x 11	25 x 21	25 x 31	25 x 41	25 x 51	25 x 61
9	28 x 11	28 x 21	28 x 31	28 x 41	28 x 51	—
10	31 x 11	31 x 21	31 x 31	31 x 41	—	—
11	34 x 11	34 x 21	34 x 31	34 x 41	—	—
12	37 x 11	37 x 21	37 x 31	37 x 41	—	—
13	40 x 11	40 x 21	40 x 31	—	—	—
14	43 x 11	43 x 21	43 x 31	—	—	—
15	46 x 11	46 x 21	46 x 31	—	—	—
16	49 x 11	49 x 21	—	—	—	—
17	52 x 11	52 x 21	—	—	—	—
18	55 x 11	55 x 21	—	—	—	—

Dimensions are in inches

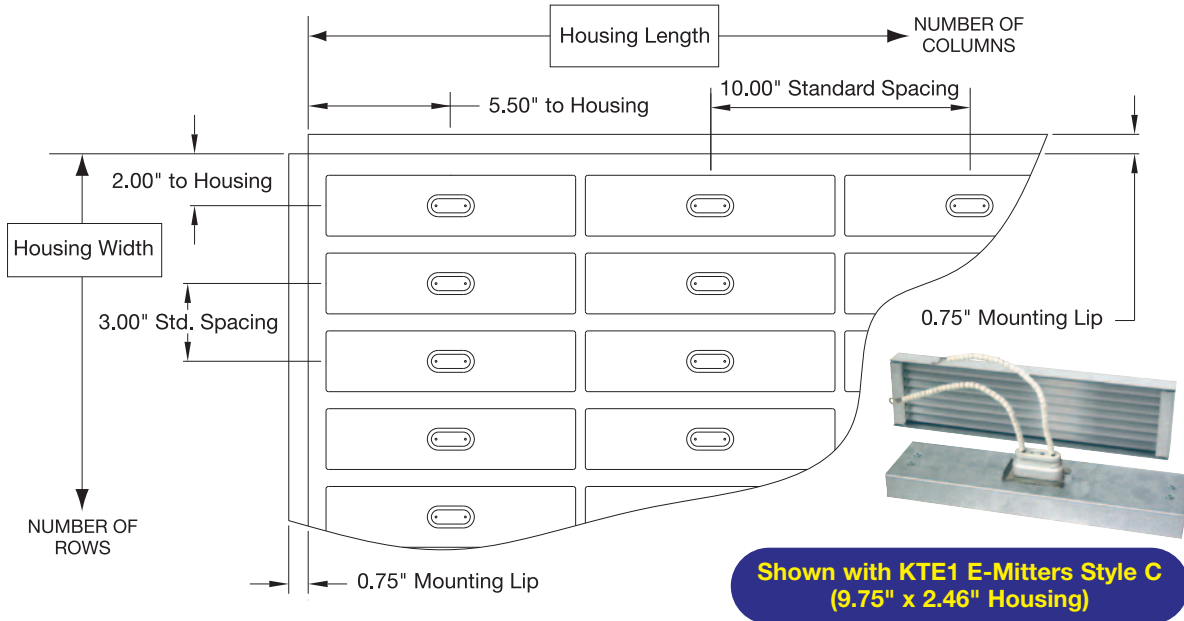

Custom Engineered/Manufactured Panels

- Multiple panels are used for larger arrays. Custom panels with other spacings are available.
- Minimum spacing for KTE1 heaters is 3.00" x 10.00". Special narrow panels having a maximum 40 rows x 1 or 2 columns, and up to 8 rows x 12 columns can be made on special order (max. housing size 121" x 25").
- Consult factory for larger panels not shown in table. Array panels can be adapted for either the 10-32 stud mount or ceramic heater style heaters. Specify heater mounting type when ordering (C or S style).

**Consult us with your requirements.
There is no substitute for experience.**

WARNING: Cancer and Reproductive Harm - www.P65Warnings.ca.gov.

Series KTE2 E-Mitter Panel Arrays Standard Style ARV Structural Housing Dimensions

- A) The Number of Rows will determine the Housing Width. For overall width add 1.50" (for the mounting lips).
 B) The Number of Columns will determine the Housing Length. For overall length add 1.50" (for the mounting lips).

Number of Rows	Number of Columns											
	1 W x L	2 W x L	3 W x L	4 W x L	5 W x L	6 W x L	7 W x L	8 W x L	9 W x L	10 W x L	11 W x L	12 W x L
1	4 x 6	4 x 11	4 x 16	4 x 21	4 x 26	4 x 31	4 x 36	4 x 41	4 x 46	4 x 51	4 x 56	4 x 61
2	7 x 6	7 x 11	7 x 16	7 x 21	7 x 26	7 x 31	7 x 36	7 x 41	7 x 46	7 x 51	7 x 56	7 x 61
3	10 x 6	10 x 11	10 x 16	10 x 21	10 x 26	10 x 31	10 x 36	10 x 41	10 x 46	10 x 51	10 x 56	10 x 61
4	13 x 6	13 x 11	13 x 16	13 x 21	13 x 26	13 x 31	13 x 36	13 x 41	13 x 46	13 x 51	13 x 56	13 x 61
5	16 x 6	16 x 11	16 x 16	16 x 21	16 x 26	16 x 31	16 x 36	16 x 41	16 x 46	16 x 51	16 x 56	16 x 61
6	19 x 6	19 x 11	19 x 16	19 x 21	19 x 26	19 x 31	19 x 36	19 x 41	19 x 46	19 x 51	19 x 56	19 x 61
7	22 x 6	22 x 11	22 x 16	22 x 21	22 x 26	22 x 31	22 x 36	22 x 41	22 x 46	22 x 51	22 x 56	22 x 61
8	25 x 6	25 x 11	25 x 16	25 x 21	25 x 26	25 x 31	25 x 36	25 x 41	25 x 46	25 x 51	25 x 56	25 x 61
9	28 x 6	28 x 11	28 x 16	28 x 21	28 x 26	28 x 31	28 x 36	28 x 41	28 x 46	28 x 51	—	—
10	31 x 6	31 x 11	31 x 16	31 x 21	31 x 26	31 x 31	31 x 36	31 x 41	—	—	—	—
11	34 x 6	34 x 11	34 x 16	34 x 21	34 x 26	34 x 31	34 x 36	34 x 41	—	—	—	—
12	37 x 6	37 x 11	37 x 16	37 x 21	37 x 26	37 x 31	37 x 36	37 x 41	—	—	—	—
13	40 x 6	40 x 11	40 x 16	40 x 21	40 x 26	40 x 31	—	—	—	—	—	—
14	43 x 6	43 x 11	43 x 16	43 x 21	43 x 26	43 x 31	—	—	Dimensions are in inches			—
15	46 x 6	46 x 11	46 x 16	46 x 21	46 x 26	46 x 31	—	—				—
16	49 x 6	49 x 11	49 x 16	49 x 21	—	—	—	—	—	—	—	—
17	52 x 6	52 x 11	52 x 16	52 x 21	—	—	—	—	—	—	—	—
18	55 x 6	55 x 11	55 x 16	55 x 21	—	—	—	—	—	—	—	—



Note: Structural Housing Dimensions (width x length) are in inches. For overall dimensions add 0.75" per side for the mounting lip.

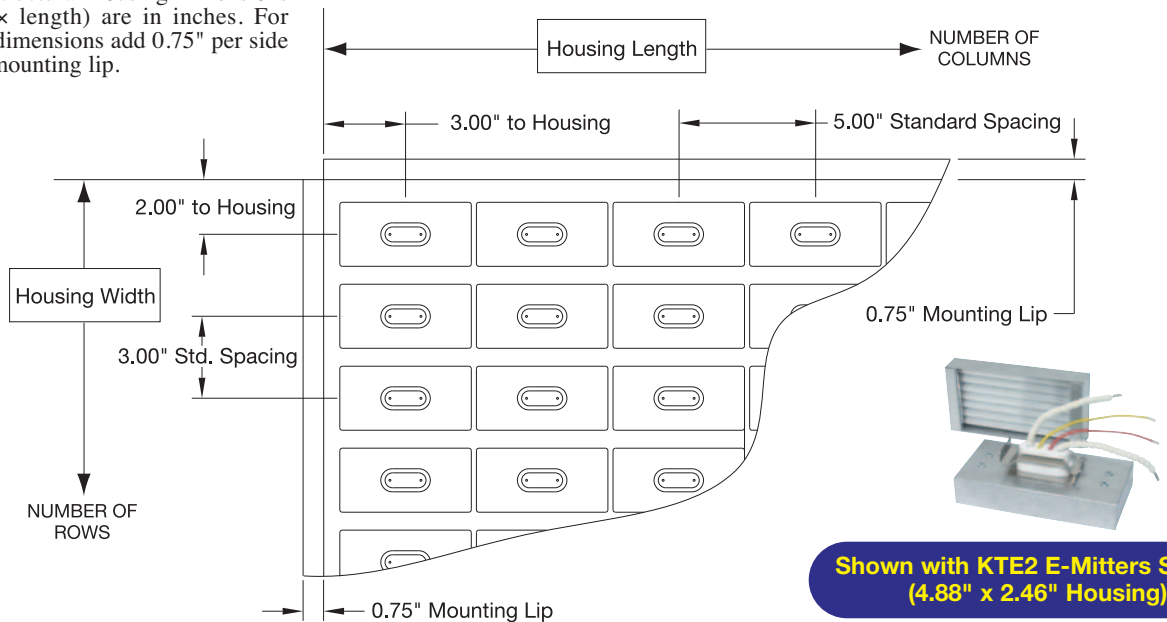

Shown with KTE2 E-Mitters Style C (4.88" x 2.46" Housing)

Custom Engineered/Manufactured Panels

- Multiple panels are used for larger arrays. Standard single panel construction is not offered beyond limits shown. Custom panels with other spacings are available.
- Minimum spacing for KTE2 heaters is 3.00" x 5.00". Special narrow panels having a maximum 40 rows x 1, 2, 3, or 4 columns, and up to 8 rows x 24 columns can be made on special order (max. housing size 121" x 25").
- Consult factory for larger panels not shown in table. Array panels can be adapted for either the 10-32 stud mount or ceramic heater style heaters. Specify heater mounting type when ordering (C or S style).

**Consult us with your requirements.
There is no substitute for experience.**

⚠ WARNING: Cancer and Reproductive Harm - www.P65Warnings.ca.gov.

Series KTE6 and KTG6 E-Mitter Panel Arrays Standard Style ARV Structural Housing Dimensions

- A) The Number of Rows will determine the Housing Width. For overall width add 1.50" (for the mounting lips).
B) The Number of Columns will determine the Housing Length. For overall length add 1.50" (for the mounting lips).

Number of Rows	Number of Columns											
	1 W x L	2 W x L	3 W x L	4 W x L	5 W x L	6 W x L	7 W x L	8 W x L	9 W x L	10 W x L	11 W x L	12 W x L
1	6 x 6	6 x 11	6 x 16	6 x 21	6 x 26	6 x 31	6 x 36	6 x 41	6 x 46	6 x 51	6 x 56	6 x 61
2	11 x 6	11 x 11	11 x 16	11 x 21	11 x 26	11 x 31	11 x 36	11 x 41	11 x 46	11 x 51	11 x 56	11 x 61
3	16 x 6	16 x 11	16 x 16	16 x 21	16 x 26	16 x 31	16 x 36	16 x 41	16 x 46	16 x 51	16 x 56	16 x 61
4	21 x 6	21 x 11	21 x 16	21 x 21	21 x 26	21 x 31	21 x 36	21 x 41	21 x 46	21 x 51	21 x 56	21 x 61
5	26 x 6	26 x 11	26 x 16	26 x 21	26 x 26	26 x 31	26 x 36	26 x 41	26 x 46	26 x 51	26 x 56	26 x 61
6	31 x 6	31 x 11	31 x 16	31 x 21	31 x 26	31 x 31	31 x 36	31 x 41	31 x 46	31 x 51	—	—
7	36 x 6	36 x 11	36 x 16	36 x 21	36 x 26	36 x 31	36 x 36	36 x 41	36 x 46	—	—	—
8	41 x 6	41 x 11	41 x 16	41 x 21	41 x 26	41 x 31	41 x 36	41 x 41	—	—	—	—
9	46 x 6	46 x 11	46 x 16	46 x 21	46 x 26	46 x 31	46 x 36	—	—	Dimensions are in inches		
10	51 x 6	51 x 11	51 x 16	51 x 21	51 x 26	51 x 31	—	—				
11	56 x 6	56 x 11	56 x 16	56 x 21	56 x 26	—	—	—				
12	61 x 6	61 x 11	61 x 16	61 x 21	61 x 26	—	—	—				



Note: Structural Housing Dimensions (width x length) are in inches. For overall dimensions add 0.75" per side for the mounting lip.

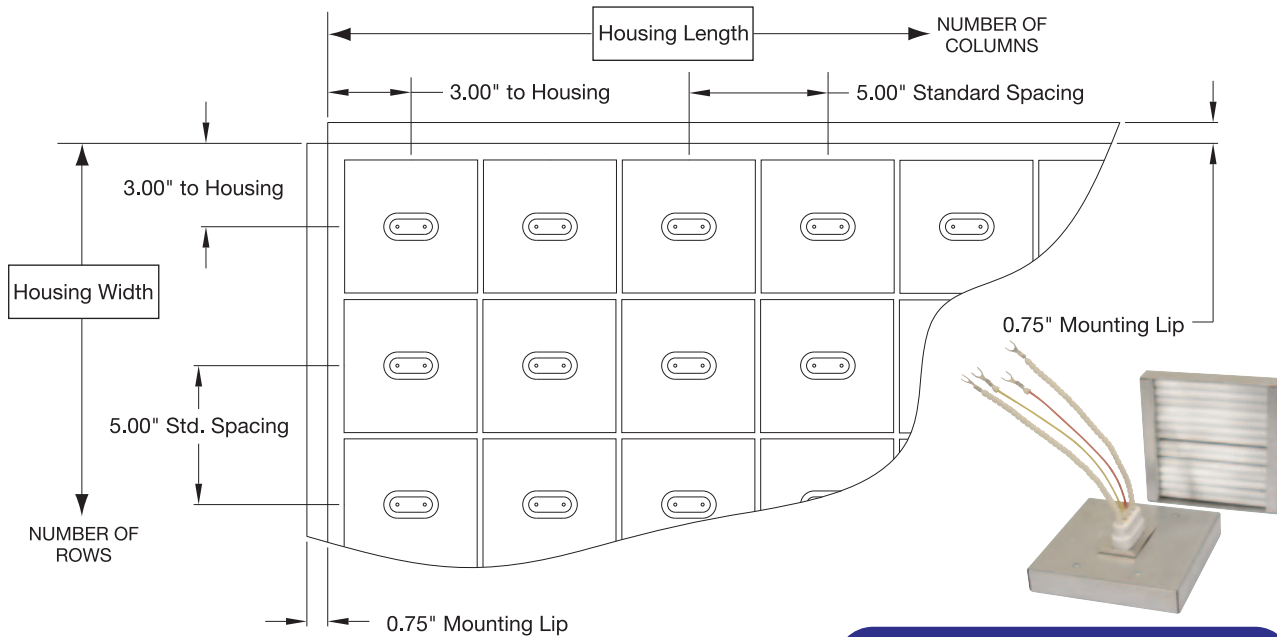

Shown with KTE6 E-Mitters Style C (4.88" x 4.88" Housing)

Custom Engineered/Manufactured Panels

- Multiple panels are used for larger arrays. Standard single panel construction is not offered beyond limits shown. Custom panels with other spacings are available.
- Minimum spacing for KTE6 heaters is 5.00" x 5.00". Special narrow panels having a maximum 25 rows x 1, or 2 columns, and up to 8 rows x 9 columns can be made on special order (max. housing size 121" x 25").
- Consult factory for larger panels not shown in table. Array panels can be adapted for either the 10-32 stud mount or ceramic heater style heaters. Specify heater mounting type when ordering (C or S style).

**Consult us with your requirements.
There is no substitute for experience.**

WARNING: Cancer and Reproductive Harm - www.P65Warnings.ca.gov.



ARV Array Panel Design Worksheet for Quartz Mini-Tube E-Mitters

Ordering Information

To process your order please specify the following information.

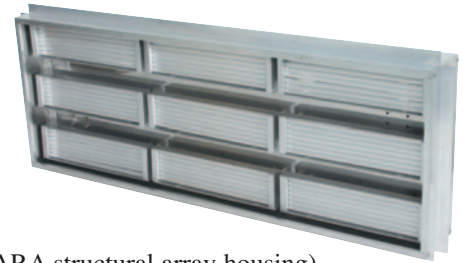

1.) Supply panel layout or sketch showing:

- Outside panel dimensions (allow for 0.75" wide mounting lip on all sides of ARA structural array housing)
- Heater type and orientation of long (or short) heater dimension
- Layout of rows and columns with number of heaters
- Spacing of rows and columns (Tempco will use standard spacing unless specified by customer)
- Zones and/or number of heaters per zone
- Locations of input wiring
- Locations of heaters with thermocouples (if used)

2.) Electrical requirements:

- Total panel KW _____
- Zone KWs (or # of heaters in zones) _____
- Line voltage to panel, # of circuits, & 1 or 3 phase operation _____
- If 480V, can series-parallel wiring and 240V heaters be used? _____
- Type of heater control to be used _____

3.) Heater Specifications:

- Heater Type KTE KTG
- Heater Size KTE1 (9-3/4"L) KTE2 (4-7/8"L) KTE3 (7-5/16"L) KTE4 (14-5/8"L) KTE5 (19-1/2"L)
 KTE6 (4-7/8" Sq.)
- Heater Mounting Style C S
- Catalog Part Number _____ or Watts _____ Volts _____
- Standard K thermocouple or optional J _____ Quantity _____
- Heater lead configuration — Standard is 3.5" or 6" with spade terminal
Spade terminals used if factory wired (ring terminals optional)

- Special marking if required _____

4.) Panel wiring & control options:

- Standard unit wiring is heaters to terminal blocks only
- Factory wired per customer specs & wiring diagram
- Tempco Engineering to design internal wiring & determine line input requirements
- Tempco to supply turnkey power control panel(s)

5.) Any special features required? _____

6.) Application Data:

- Type of application and physical properties of processed materials

⚠ WARNING: Cancer and Reproductive Harm - www.P65Warnings.ca.gov.

(800) 323-6859 • Email: sales@tempco.com