

Mi-Plus[®] Mineral Insulated Band Heater

**A High Performance Band Heater With Outstanding Design Features
(Temperature Capabilities To 1400°F/760°C)**



1400!
*?@#%!+\$
Later, I'm
Callin' Our
Travel
Agent!

You've Got
to Love
Those Igloo™
Terminal
Covers.
His & Her
Entrances!

Check Out
These
Smooth
Inside
Seams.
Hmmm...
Tight
Seals!

I've Heard
Not Even a
Chicago Bear
Can Break the
Screw
Terminals.

Bear?...
Who Said
Bear?
I'm Outta
Here!!!

Hey You Guys, Feast
Your Eyes on the
Selection and
Construction Styles.

WOW!
and
The Cool
Blue is
Totally
In!

Tough
One-
Piece
Integral
Clamping
Bracket.

One-Piece,
Two-Piece
and One-
Piece
Expandable
Construction.
Speaking of
Expandable...
Nice Swim-
suit.

Yep, and
Made to
Order
Too!

From
Stock?

Mi-Plus® Construction Characteristics

The *Mi-Plus* is the solution for applications that require high watt densities (W/in^2) and/or high operating temperatures. *Mi-Plus* band heaters are capable of temperatures up to 1400°F (760°C) and watt densities up to 150W/in² (23.25W/cm²). The recommended maximum watt density for a specific application will depend on the heater size and its operating temperature.

Specially formulated mineral insulated tape that provides excellent thermal conductivity and dielectric strength is used to insulate the nickel chrome resistance wire from the stainless steel sheath. The heater assembly is formed under pressure to a precise diameter with a thin, low-mass cross section, assuring fast heat-up rates and reduced cycle times.

UNBREAKABLE Power Screw Terminals

Only Mi-Plus offers this unique screw terminal design...
The stainless steel power screw terminals are resistant to over-torquing. **For complete selection of screw terminal arrangements, see pages 1-14 and 1-15.**



SUPERIOR Clamping Mechanism

The clamping brackets are formed from the outer sheath of the heater, providing a unique, one-piece, built-in construction strap. The clamping power is generated through barrel nuts and socket head screws, which, as

an integral part of the built-in strap, provide superior clamping force for maximum performance and optimal heater life. **For details, see pages 1-12 and 1-13.**

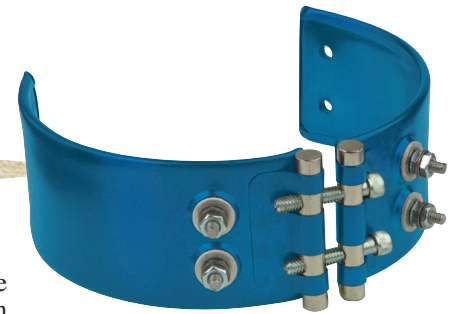

INNOVATIVE Lead Terminations

Smaller size *Mi-Plus* band heaters are powered-up by means of lead wire terminations. To insure a resilient connection that will withstand abrasion, mechanical abuse and keep contaminants out of the transition area, a specially designed stainless

steel transition cap with a built-in strain relief was developed. The cap is welded to the sheath and the cavity is filled with insulating cement, sealing the band heater from contaminants. **For details, see pages 1-16 through 1-19.**

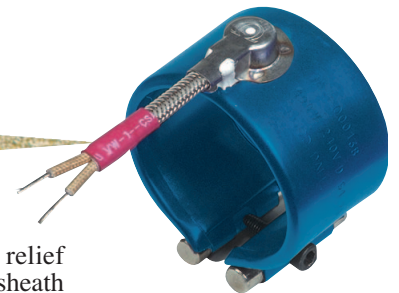

UNIQUE Igloo™ Ceramic Covers

To eliminate exposed wiring/screw terminals on band heater installations, single and double port ceramic caps were designed. These unique and exclusive Igloo ceramic terminal

insulators fit over the entire terminal and lug, leaving no exposed wiring. **For additional details on Igloo insulators, see page 1-15.**





Mi-Plus® Standard Specifications and Tolerances

PERFORMANCE RATINGS

Maximum Temperature: 1400°F (760°C)

Nominal Watt Density:

Nozzle Bands — under 3" diameter:
30-100 W/in² (4.7-15.5 W/cm²)

Barrel bands — 3" and greater in diameter:
20-70 W/in² (3.1-10.9 W/cm²)

Maximum Watt Density: 150 W/in² (23 W/cm²) Dependent on heater size, operating temperature and termination.

ELECTRICAL RATINGS

Maximum Voltage: 480VAC per termination

Dual Voltage: Available depending on heater configuration

Maximum Amperage: lead wire termination: 12.5A
screw terminations: 8-32UNF—20A
10-32UNF—25A

Resistance Tolerance: +10%, -5%

Wattage Tolerance: +5%, -10%



Exposed electrical wiring on band heater installations is a violation of Electrical Safety Codes including O.S.H.A.

PHYSICAL SIZE CONSTRUCTION LIMITATIONS

Nominal Gap—Built-In Bracket:

less than 1-3/4" dia. 1/4"
1-3/4" to 2" dia. 5/16"
2" to 5" dia. 3/8"
5" to 18" dia. 1/2"
greater than 18" dia. 3/4"

If a larger gap is required for probes or thermocouples, specify when ordering.

Maximum Inside Diameters:

One-Piece *14" (355.6 mm)
One-Piece Expandable .. *14" (355.6 mm)
Two-Piece 25" (635.0 mm)
Over 25" (635.0 mm) will require multiple segments. Consult TEMPCO.

* *Tempco recommends two-piece construction for heaters 10" ID and greater*

Standard Widths: 1" to 8" (25.4 mm to 203.2 mm)

Width Tolerance: ±3/32" (2.4 mm)

If non-standard widths or tighter tolerances are required, consult Tempco.

Diameter/Width Limitations

Width		One-Piece Construction Inside Diameter		Expandable Construction Inside Diameter		Two-Piece Construction Inside Diameter	
in	mm	in	mm	in	mm	in	mm
1	25.4	1 to 10	25.4 to 254.0	N/A	N/A	3 to 25	76.2 to 635.0
1½	38.1	1 to 14	25.4 to 355.6	2½ to 14	63.5 to 355.6	3 to 25	76.2 to 635.0
2	50.8	1½ to 14	38.1 to 355.6	2½ to 14	63.5 to 355.6	3 to 25	76.2 to 635.0
2½	63.5	1½ to 14	38.1 to 355.6	2½ to 14	63.5 to 355.6	3 to 25	76.2 to 635.0
3	76.2	1½ to 14	38.1 to 355.6	2½ to 14	63.5 to 355.6	3 to 25	76.2 to 635.0
3½	88.9	1¾ to 14	44.5 to 355.6	2½ to 14	63.5 to 355.6	3 to 25	76.2 to 635.0
4	101.6	2 to 14	50.8 to 355.6	2½ to 14	63.5 to 355.6	3 to 25	76.2 to 635.0
4½	114.3	2¼ to 14	57.2 to 355.6	2½ to 14	63.5 to 355.6	3 to 25	76.2 to 635.0
5	127.0	2½ to 14	63.5 to 355.6	2½ to 14	63.5 to 355.6	3 to 25	76.2 to 635.0
5½	139.7	2¾ to 14	69.9 to 355.6	3 to 14	63.5 to 355.6	3 to 25	76.2 to 635.0
6	152.4	3 to 14	76.2 to 355.6	3 to 14	76.2 to 355.6	3 to 25	76.2 to 635.0
6½	165.1	3¼ to 14	82.6 to 355.6	3¼ to 14	82.6 to 355.6	3¼ to 25	82.6 to 635.0
7	177.8	3½ to 14	88.9 to 355.6	3½ to 14	88.9 to 355.6	3½ to 25	88.9 to 635.0
7½	190.5	3¾ to 14	95.3 to 355.6	3¾ to 14	95.3 to 355.6	3¾ to 25	95.3 to 635.0
8	203.2	4 to 14	101.6 to 355.6	4 to 14	101.6 to 355.6	4 to 25	101.6 to 635.0

Additional Limitations

- For heaters less than 4" in diameter, the maximum width is twice the diameter.
- Heaters with standard brackets are available from 1" to 8" wide, while heaters with low profile brackets are available from 1" to 6" wide.
- 1" diameter heaters are only available in 1" and 1-1/2" widths.
- For heaters from 10" diameter up to 25" diameter, Tempco recommends using 2-piece construction for superior clamping. Over 25" diameter, 3 or 4 segments are recommended.
- Combinations of some minimum and maximum variations may not be available. Consult Tempco with your special requirements.
- Post terminals are only available on heaters greater than 2-1/2" in diameter and 1-1/2" in width.

Mi-Plus® Maximum Watt Densities

MAXIMUM ALLOWABLE WATT DENSITY

The chart displays the maximum Watt Density curves for various diameter heaters. Use this chart when determining the appropriate wattage value for your chosen heater.

Be aware that certain factors will require you to derate the watt density (W/in²) of your heater selection.



Failure to adhere to the maximum allowable watt density per heater size will result in poor operating life.

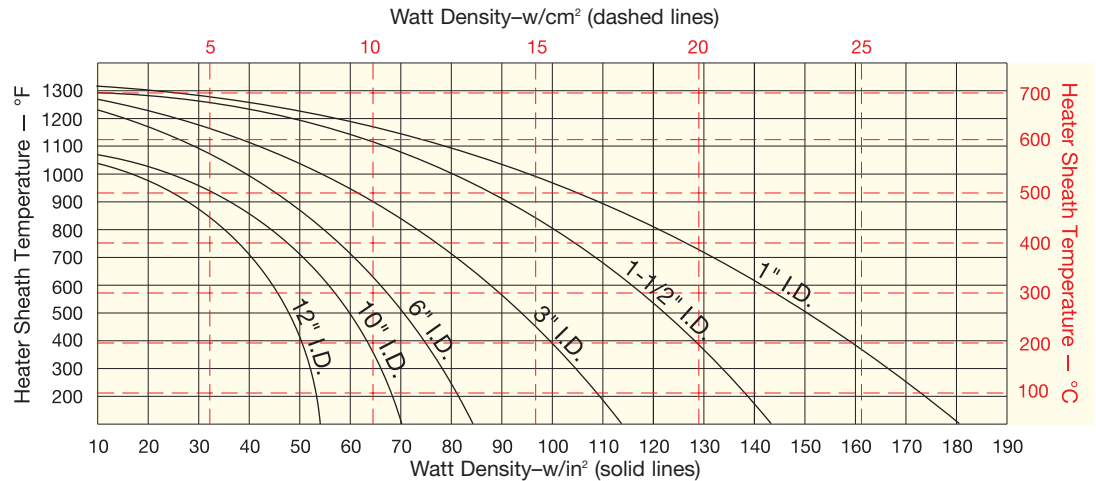

CALCULATING MAXIMUM WATT DENSITY

Factors to be taken into consideration:

- Type of controls
- Voltage variations
- Machine cycling rate
- Type of resin being processed
- Coefficient of thermal expansion and conductivity of the cylinder.
- Designing a heater that closely matches the wattage requirement will decrease the frequency of cycling and temperature overshoot, thereby increasing the life of the heater.

Once these factors have been established, proceed with the following steps:

- Determine the maximum operating temperature.
- Calculate the total wattage required to obtain the maximum operating temperature.
- Determine the quantity and size of the heater bands to be used. Due to clamping concerns, 2" through 3" wide band heaters have long proven to be the most efficient and reliable in most cylindrical heating applications.
- Determine individual band heater wattage by dividing the total required wattage by the quantity of band heaters selected.

- Determine the band heater's heated area by subtracting unheated (cold) areas created by screw terminals, gaps, holes, and cutouts.

Nominal Unheated Areas

Construction Style	Cold Area to Subtract
One-piece band	1" × width
One-piece expandable band	1½" × width
Two-piece band	2" × width

For each hole or cutout add to the cold area from the Table the (Hole size + ½") × heater width. This is total cold area to use in the following formula to calculate the heater watt density.

Watt Density Formula

$$\text{Watt Density (W/in}^2\text{)} = \frac{\text{Wattage}}{(3.14 \times \text{Band ID} \times \text{Band Width}) - (\text{Cold Area})}$$

- Check in the above graph that the calculated watt density does not exceed the maximum recommended watt density. Locate the maximum cylinder temperature required on the left-hand side of the graph, follow the horizontal line until it intersects with the line of the band heater being used, and read directly down to obtain the maximum recommended watt density (watts/in²).
- If the calculated watt density is higher than the recommended value, it must be corrected or it will cause poor heater life. This can be accomplished by using more band heaters or lowering the heater wattage.
- Should you have a problem in selecting the proper band heater or establishing watt density for your application, consult Tempco.

CORRECTION FACTORS

For heaters wider than 3" (76.2 mm), reduce maximum allowable watt density from chart by 20%.

For applications using insulating shroud, reduce maximum allowable watt density from chart by 25%.



Do not use insulating blankets if heater temperatures are above 1200°F (649°C). Failure to adhere will result in premature heater failure.

Mi-Plus[®] Terminator Program

Mi-Plus Nozzle Band Heaters
Available From Stock
Within 48 Hours

6
Terminations
To Choose From

Type W1

Straight wire
braid leads;
for complete details
refer to page 1-16

Type W2

Right-angle wire
braid leads, parallel
to heater; for
complete details
refer to page 1-16

Type W5

Right-angle wire
braid leads, 90
degrees to heater;
for complete details
refer to page 1-17

Type L1

Plain wire leads; for
complete details
refer to page 1-19

Type R1

Straight armor cable;
for complete details
refer to page 1-17

Type R2

Right-angle armor cable;
for complete details refer
to page 1-18

Mi-Plus[®] Band Heater Terminator Program

These Mi-Plus Band Heaters are in-stock, semi-finished (substrates), offering the option to finish them by choosing from the 6 program-qualified lead end terminations listed above.

Mi-Plus Terminator Band Heaters will be ready for shipment within 48 hours.

Stock Mi-Plus® Nozzle Band Heaters Available Through the Terminator Program

Part Numbers listed are for Heaters with Type W2 Termination – Right-Angle Wire Braid Leads (12" leads, 10" SS braid). Other Terminator Program terminations and options can also be applied to stock heaters (see Ordering Information below).

ID	Width		Wattage	Watt Density		Clamping/ Construction	Part Number		
	in	mm		in	mm		W/in ²	W/cm ²	120V
1	25.4	1	25.4	150	70	10.9	WB	MPP50101	—
1	25.4	1	25.4	225	105	16.3	WB	—	MPP50206
1	25.4	1-1/2	38.1	200	62	9.7	WB	MPP50301	MPP50401
1	25.4	1-1/2	38.1	250	78	12.1	WB	—	MPP50601
1	25.4	1-1/2	38.1	300	93	14.5	WB	MPP50701	MPP50801
1-1/4	31.8	1	25.4	250	85	13.2	WB	MPP51101	MPP51202
1-1/4	31.8	1	25.4	275	94	14.6	WB	—	MPP51401
1-1/4	31.8	1-1/2	38.1	350	80	12.4	LB	MPP51701	—
1-1/4	31.8	1-1/2	38.1	350	80	12.4	WB	—	MPP51801
1-1/2	38.1	1	25.4	200	54	8.4	OB	MPP51901	MPP52001
1-1/2	38.1	1	25.4	225	61	9.5	OB	MPP02836	MPP02837
1-1/2	38.1	1	25.4	300	81	12.5	OB	MPP52301	MPP52402
1-1/2	38.1	1-1/2	38.1	300	54	8.4	LB	MPP52501	MPP52602
1-1/2	38.1	1-1/2	38.1	350	63	9.8	LB	MPP02352	MPP02353
1-1/2	38.1	1-1/2	38.1	450	81	12.5	LB	—	MPP52903
1-1/2	38.1	2	50.8	300	40	6.3	LB	—	MPP53001
1-1/2	38.1	2	50.8	400	55	8.5	LB	MPP02838	MPP00494
1-1/2	38.1	2	50.8	450	61	9.4	LB	—	MPP53202
1-1/2	38.1	3	76.2	350	31	4.9	LB	—	MPP53401
1-1/2	38.1	3	76.2	500	45	7.0	LB	—	MPP53501
1-3/4	44.5	1-1/2	38.1	300	44	6.9	LB	MPP53801	MPP53901
1-3/4	44.5	2	50.8	750	83	12.9	LB	—	MPP54301
1-3/4	44.5	2-1/2	63.5	550	49	7.6	LB	—	MPP54401
1-3/4	44.5	3	76.2	1000	74	11.5	LB	—	MPP54601
2	50.8	1	25.4	350	66	10.3	OB	MPP54701	MPP54801
2	50.8	1-1/2	38.1	400	50	7.8	LB	—	MPP54901
2	50.8	1-1/2	38.1	425	54	8.4	LB	MPP02839	MPP02840
2	50.8	2	50.8	750	71	11	LB	MPP55051	MPP55101
2-1/4	57.2	1	25.4	350	58	8.9	OB	—	MPP55401
2-1/4	57.2	2-1/2	63.5	1000	66	10.2	LB	—	MPP55801
2-1/2	63.5	1	25.4	400	58	9.0	OB	—	MPP56001
2-1/2	63.5	1-1/2	38.1	500	49	7.5	LB	—	MPP56101
2-1/2	63.5	1-1/2	38.1	525	51	7.9	LB	MPP02841	MPP00227

Ordering Information

Order by Part Number for stock Mi-Plus heaters with Type W2 termination. Call Tempco for part numbers for stock heaters with other Terminator Program (see page 1-6) terminations and options.

Custom Engineered/Manufactured

Mi-Plus Heaters can be application specific; therefore for sizes, electrical ratings, terminations and any other design features not listed in this catalog **TEMPCO** will custom manufacture to your specifications. Consult us with your requirements.



Standard Sizes and Ratings

Stock and Standard (Non-Stock) Mi-Plus Barrel Band Heaters

Part Numbers listed are for Heaters with Screw Terminal Terminations – Type T2 or T3X.

Part numbers for heaters with other terminations will be assigned at time of order.

Stock Items Are Shown In **RED**

ID		Width		Wattage	Voltage	Watt Density		Style	Clamping/ Construction	Terminal	Part Number
in	mm	in	mm			W/in ²	W/cm ²				
3	76.2	1-1/2	38.1	500	240	41	6.3	1 pc	NB	T2	MPP00230
3	76.2	1-1/2	38.1	525	240	43	6.6	1 pc	NB	T2	MPP00231
3-1/4	82.6	2-1/2	63.5	1100	120	48	7.4	1 pc	NB	T3X	MPP00232
3-1/4	82.6	2-1/2	63.5	1400	240	61	9.4	1 pc	NB	T3X	MPP00233
3-1/2	88.9	2	50.8	800	240	40	6.2	1 pc	NB	T3X	MPP00234
3-5/8	92.1	1-1/2	38.1	650	240/480	52	8	Exp	NE	T2	MPP00235
4	101.6	1-1/2	38.1	625	240/480	44	6.8	Exp	NE	T2	MPP00236
4	101.6	1-1/2	38.1	725	240/480	51	7.8	Exp	NE	T2	MPP00237
4	101.6	1-1/2	38.1	800	240	47	7.3	1 pc	NB	T2	MPP00238
4-1/2	114.3	2-1/2	63.5	1250	240	38	5.9	1 pc	NB	T3X	MPP00186
5	127	1-1/2	38.1	1000	240/480	52	8.1	Exp	NE	T2	MPP00239
5-1/4	133.4	1-1/2	38.1	600	240/480	30	4.6	Exp	NE	T2	MPP00240
5-1/4	133.4	1-1/2	38.1	1000	240/480	49	7.7	Exp	NE	T2	MPP00241
5-1/4	133.4	3	76.2	1700	240/480	39	6.1	Exp	NE	T3X	MPP00187
5-1/4	133.4	4-1/2	114.3	2400	240/480	37	5.7	Exp	NE	T3X	MPP00242
5-1/4	133.4	4-1/2	114.3	2700	240/480	41	6.4	Exp	NE	T3X	MPP00243
5-1/2	139.7	1-1/2	38.1	1000	240/480	47	7.2	Exp	NE	T2	MPP00244
5-1/2	139.7	1-1/2	38.1	1300	240/480	61	9.4	Exp	NE	T2	MPP00245
6	152.4	1-1/2	38.1	1000	240/480	42	6.5	Exp	NE	T2	MPP00246
6	152.4	1-1/2	38.1	1400	240/480	59	9.1	Exp	NE	T2	MPP00247
6-1/2	165.1	1-1/2	38.1	1250	240/480	48	7.4	Exp	NE	T2	MPP00248
6-3/4	171.5	1-1/2	38.1	815	240/480	30	4.6	Exp	NE	T2	MPP00249
6-3/4	171.5	1-1/2	38.1	1000	240/480	37	5.7	Exp	NE	T2	MPP00250
6-3/4	171.5	4	101.6	2600	240/480	34	5.2	Exp	NE	T3X	MPP00188
6-3/4	171.5	5	127	3700	240/480	39	6	Exp	NE	T3X	MPP00251
6-3/4	171.5	6	152.4	3750	240/480	33	5	Exp	NE	T3X	MPP00189
7	177.8	1-1/2	38.1	1250	240/480	44	6.8	Exp	NE	T2	MPP00252
7	177.8	1-1/2	38.1	1500	240/480	53	8.2	Exp	NE	T2	MPP00253
7-1/2	190.5	1-1/2	38.1	1500	240/480	49	7.5	Exp	NE	T2	MPP00254
7-5/8	193.7	3	76.2	1800	240/480	27	4.2	Exp	NE	T3X	MPP00255
7-5/8	193.7	4-1/2	114.3	3150	240/480	32	4.9	Exp	NE	T3X	MPP00190
8	203.2	1-1/2	38.1	1250	240/480	38	5.8	Exp	NE	T2	MPP00256
8	203.2	1-1/2	38.1	1600	240/480	48	7.5	Exp	NE	T2	MPP00257
9	228.6	1-1/2	38.1	1500	240/480	40	6.1	Exp	NE	T2	MPP00258
9	228.6	1-1/2	38.1	1750	240/480	46	7.2	Exp	NE	T2	MPP00259
9-1/2	241.3	3	76.2	3000	240/480	36	5.6	Exp	NE	T3X	MPP00191
11-1/4	285.8	3	76.2	2400	240/480	24	3.7	Exp	NE	T3X	MPP00260
11-1/4	285.8	5	127	5100	240/480	31	4.7	Exp	NE	T3X	MPP00261

Stock Mi-Plus Barrel Band Heaters are ready for immediate shipment with Screw Terminals.

Complete termination details are on pages 1-14 and 1-15.

Ordering Information

Stock Heaters

Select a Mi-Plus Barrel Band Heater from the list above.

Stock heaters can be modified to the following terminations:

- Type C—Outlet terminal box.
- Type P2—Low profile high temperature quick disconnect.
- Type C6, C7 and C8—Igloo™ ceramic terminal covers.

Custom Engineered/Manufactured Heaters

An electric heater can be very application specific; for sizes not listed **TEMPCO** will design and manufacture a Mi-Plus Barrel Heater to meet your requirements. **Standard lead time is 5 weeks.**

Please Specify the following:

- Inside Diameter
- Width
- Wattage
- Voltage
- Quantity
- Termination (see pages 1-14 through 1-21)
- Lead Cable/Braid Length
- Construction Style (see pages 1-10 and 1-11)
- Clamping Variation (see pages 1-12 and 1-13)
- Features/Options (see page 1-22)

WARNING: Cancer and Reproductive Harm - www.P65Warnings.ca.gov.

Special and Unique Mi-Plus® Band Heater Designs

Throughout our catalog we show Tempco's standard specifications and most popular designs. However, as a custom heating element manufacturer, we recognize that many applications require non-standard and unique designs.

At Tempco, we are constantly challenged by our customers to solve their heating applications. We have the experience, technical knowledge and manufacturing capability to solve all your heating problems with unique heater designs. Use Tempco's talent and capabilities to your benefit to solve your specific heating problem in an expeditious and cost-effective manner.

The following pictures show some of the heater designs that we have developed for special applications. Next time, when you have a special application and you want someone to work with you and "think outside the box" to solve your specific heating application, call Tempco.

We haven't seen all heating applications, but most likely our experienced staff has seen and solved more heating problems than you have seen.

*Put our knowledge and experience to work for you.
Challenge us! You will be glad you did.*

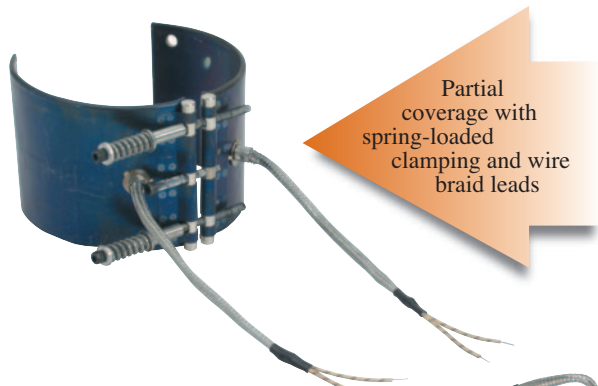

Partial coverage with spring-loaded clamping and wire braid leads

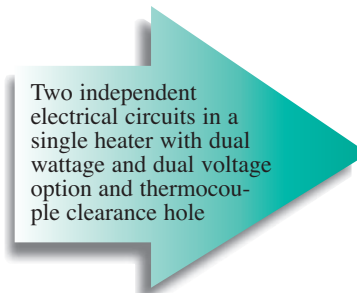

Two independent electrical circuits in a single heater with dual wattage and dual voltage option and thermocouple clearance hole

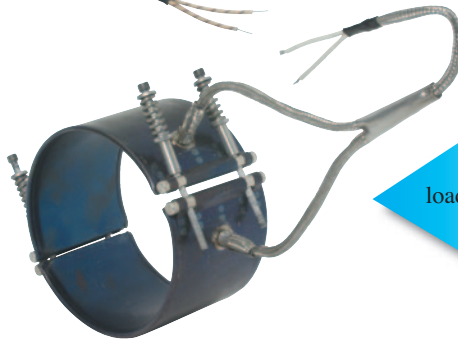

Two-piece heater with spring-loaded clamping and single leads for easy wiring

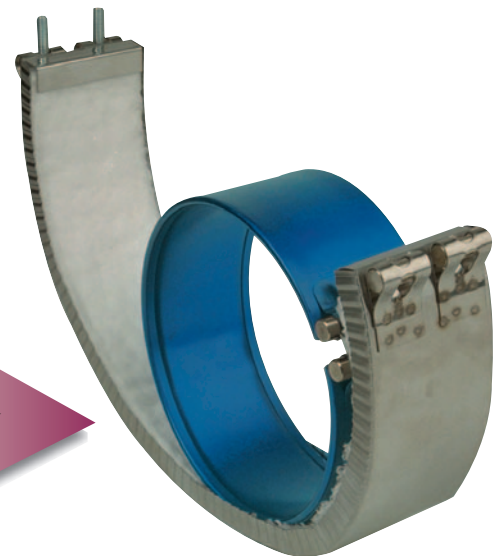

Heater with insulating shroud to minimize energy losses

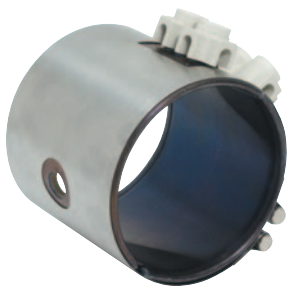

Heater with separate strap designed for three-phase operation, with ground terminal and thermocouple clearance hole

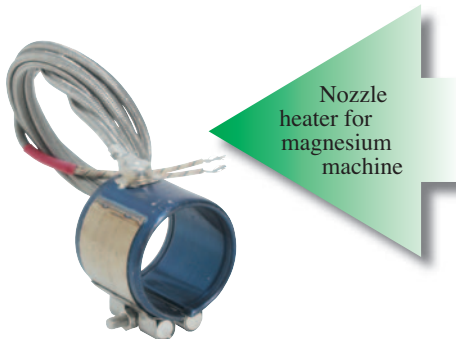

Nozzle heater for magnesium machine

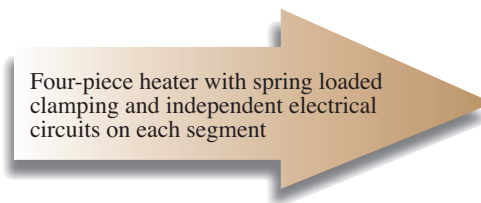

Four-piece heater with spring loaded clamping and independent electrical circuits on each segment

Mi-Plus® Construction Styles



Do not open Non-Expandable One-Piece Mi-Plus Band Heaters during installation. Opening this construction style will cause internal damage.



Shown with Type NB Built-In Strap



Shown with Type NS Built-In Strap



It is not recommended to open a One-Piece Expandable Band Heater more than two times.

Shown with Type NE Built-In Strap

Mi-PLUS BAND HEATERS...



Note: Refer to page 1-4 for complete Limitations on Physical Size Construction.

Non-Expandable One-Piece Band Construction

One-piece heaters are the most efficient construction, as they provide the most heated surface area. This style can only be used where the entire heater can be slipped over the end of the barrel. One-piece heaters have built-in, full-width clamping bars.

Two-Piece Band Construction

Two-piece construction satisfies the need for a heater that can be placed anywhere along the machine barrel with a minimum of time and labor. Two-piece construction is recommended for larger diameter heaters because two-piece construction employs two sets of built-in clamps that deliver maximum clamping force.

The two-piece construction style also provides dual voltage capability. The heater halves may be wired together either in series or parallel, providing two voltage options. Two-piece heaters are rated at full voltage and 1/2 the total wattage for each half. On very large custom applications, Tempco may suggest going to multiple Mi-Plus heater segments with spring-loaded clamping.

One-Piece Expandable Band Construction

The expandable construction style allows the heater to be opened up and placed anywhere along the machine barrel, as well as minimizes the unheated area as compared to a two-piece heater.

With two heater circuits in a common case this heater naturally lends itself to a dual voltage system, a 240/480 volt package being the most common. When wired in parallel these heaters can run at 240 volts, and when wired in series, at 480 volts.

Expandable heaters are rated for each circuit at full voltage and one half of the total wattage.

Mi-Plus® Construction Styles — Special Variations

**Partial Coverage Band
2-Piece with Built-In Brackets**

Partial coverage band heaters are required when an obstruction on the barrel would interfere with a full coverage band.

The preferred method of construction is the 2-piece Band Heater with Built-In Brackets as illustrated below. The heater is bolted down to the cylinder at the ends and the built-in low thermal expansion strap pulls the heater tightly against the cylinder being heated. The standard center of hole to edge of heater dimension is 1/4".

When ordering, specify the angle of coverage from center to center of the mounting screw holes as shown.

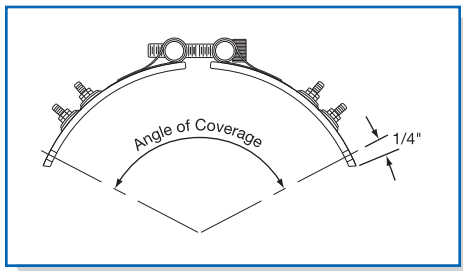

**Partial Coverage Band
1-Piece with Separate Strap**

The alternate method of partial coverage construction is the 1-piece Band Heater with a separate 2-piece strap.

The 2-piece strap itself is bolted at the padded ends, allowing the heater to float between the pads as illustrated below. When tightening the strap, it will pull the heater against the cylinder being heated. The standard center of hole to edge of heater dimension is 1/4".

When ordering, specify the angle of coverage from center to center of the mounting screw holes as shown.

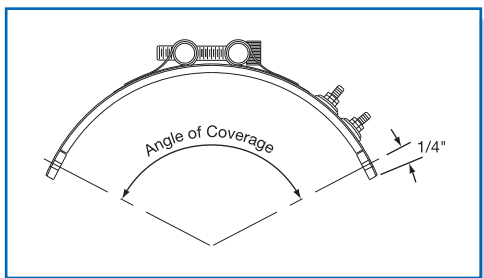

Clamping Variations

Mi-Plus® Standard Built-In Clamping Strap

The clamping brackets of the Mi-Plus Heater are formed from its outer sheath, producing a unique Built-In Strap. Clamping power is generated through barrel nuts and socket head cap screws, which are an integral part of the Built-In Strap.

High operating temperatures require superior clamping force to maintain ultimate contact between the inside diameter of the band heater and the barrel, which is essential for maximum heater operating life. Only Tempco's Mi-Plus offers you this unique Built-In Strap feature.

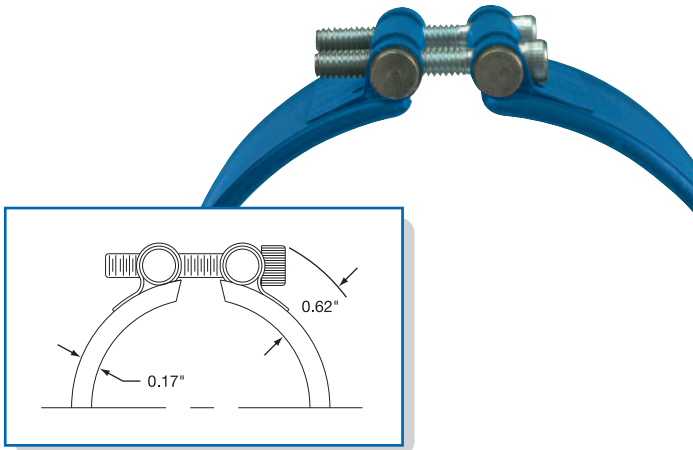

TOUGH IN EXTREME CONDITIONS

Even under the most extreme conditions, the Built-In Strap Clamping will remain functional for the life of your Mi-Plus band heater. The steel clamping bars are the full width of the heater to distribute the forces evenly for superior heater contact. Tempco uses 1/4-20 alloy steel socket head cap screws to maximize the clamping power.

Standard on all Mi-Plus heaters 3" in diameter & larger

Limitations **Minimum Width:** 1-1/2" (38.1 mm)
Minimum Diameter: 3" (76.2 mm)

Type NB — One-Piece Band

Type NS — Two-Piece Band

Type NE — One-Piece Expandable Band

Consult Tempco for multiple segment heaters.

Mi-Plus Separate Clamping Straps



The Mi-Plus is available without built-in brackets. This option uses a separate strap to properly clamp the heater. A separate strap is useful when clearance is limited or there is an obstruction. Separate straps are made strictly to customer specifications. Consult Tempco with your requirements.

Bolt Size	Clearance	Suggested Diameter Range
8-32	.50"	1" – 3"
10-32	.56"	2" – 6"
1/4-20	.62"	> 3"



Note: The number of straps is dependent on heater width. Tempco recommends the use of the largest bolt size that clearance allows.

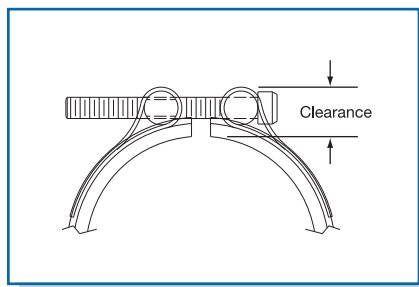

Type SB — One-Piece Band

Type SS — Two-Piece Band
 (Requires Minimum Heater Diameter of 3")

Type SE — One-Piece Expandable Band
 (Requires Minimum Heater Diameter of 3")

Consult Tempco for multiple segment heaters.

Mi-Plus® Built-In Clamping Strap Variations

Mi-Plus Low Profile Built-In Clamping Strap

When space is limited use Tempco's low profile clamping, a design that doesn't sacrifice strength for size. This compact design uses 10-32 alloy socket head cap screws.

Standard on all Mi-Plus heaters less than 3" in diameter

Limitations **Minimum Width:** 1-1/2" (38.1 mm)
Minimum Diameter: 1-3/8" (34.9 mm)

Type LB — One-Piece Band

Type LS — Two-Piece Band

Type LE — One-Piece Expandable Band

Consult Tempco for multiple segment heaters.

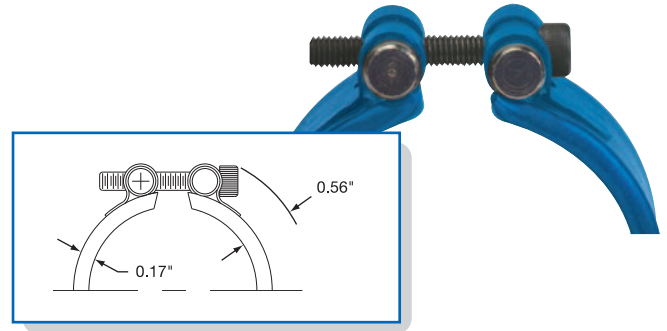

Mi-Plus Outrigger Built-In Clamping Strap

This design is unique to 1" wide heaters from 1-3/8" diameter and greater. Two 8-32 alloy socket head cap screws are used to give 1" wide heaters the required clamping power.

Standard on Mi-Plus heaters 1" wide and 1-3/8" in diameter and greater.

Type OB — One-Piece Band

Type OS — Two-Piece Band

Consult Tempco for multiple segment heaters.

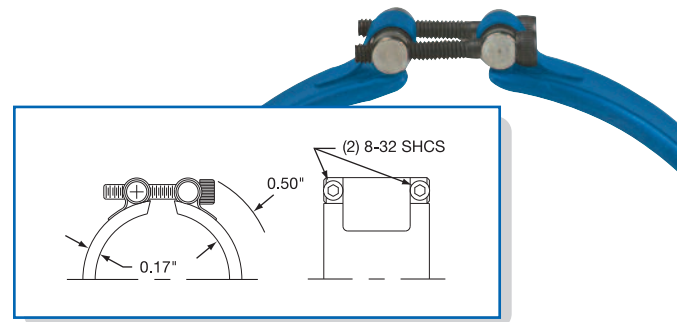

Mi-Plus Spring Loaded Built-In Clamping Strap

Spring loaded clamping with alloy steel socket head cap screws is standard on heaters over 8" in diameter and offered as an option on any heater with standard brackets. The extra heavy duty compression springs serve to combat thermal expansion of the heater by self adjustment, thereby ensuring excellent contact of the heater surface with the machine barrel or die. This type of clamping is also useful on heaters that are mounted vertically.

Limitations

Minimum Width: 1-1/2" (38.1 mm)

Minimum Diameter: 3-1/2" (88.9 mm)

Type SL — One-Piece Band

Type NSL — Two-Piece Band

Type NEL — One-Piece Expandable Band

Consult Tempco for multiple segment heaters.

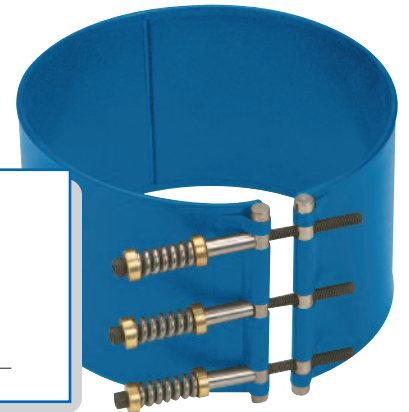
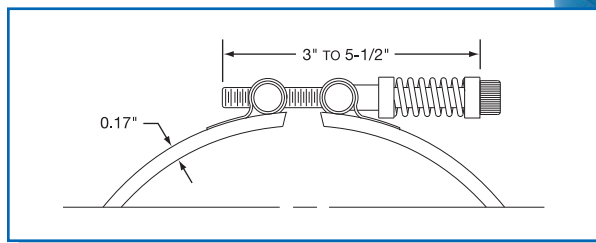

Mi-Plus Weld-On Bracket

The Mi-Plus is available without built-in brackets. For this option, brackets are welded onto the heater plate at user-specified locations. A weld-on bracket is useful when clearance is limited or there is an obstruction for using separate straps. Consult Tempco with your requirements.

Limitations **Minimum Width:** 1" (25.4 mm)

Minimum Diameter: 1" (25.4 mm)

Type WB — One-Piece Band

Type WS — Two-Piece Band

Type WE — One-Piece Expandable Band

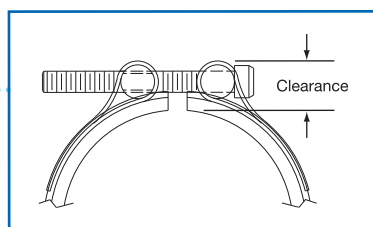

Bolt Size	Clearance
8-32	.50"
10-32	.56"
1/4-20	.62"



Note: The number of weld-on brackets is dependent on heater width. Tempco recommends the use of the largest bolt size that clearance allows.

Terminations

Screw Terminals: Type T2, Type T3X & Type T3Y

The specially designed Stainless Steel Power Terminals are internally connected to the heater and are resistant to over-torquing. The screw terminals are virtually unbreakable. Secure tightening of the electrical connections is essential for safety and long heater life.

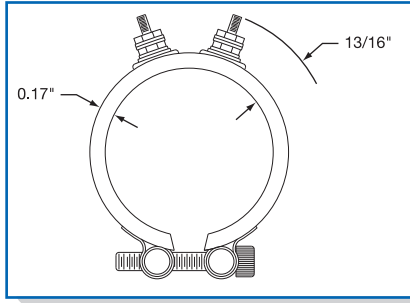

Mi-Plus Type T2 — Screw Terminals



One-Piece Band

Standard Termination Location:
opposite the gap; center of width

- * **Minimum Inside Diameter:** 2-1/2" (63.5 mm)
- * **Minimum Width:** 1-1/2" (38.1 mm)
- * **Post Terminals:** 10-32 or 8-32
- * **Maximum Volts:** 480VAC
- * **Maximum Amps:** 25A (10-32) or 20A (8-32)



Only Tempco's Mi-Plus has these unique Torque-Resistant Power Terminals.

Two-Piece Band

Standard Termination Location:
center of each half; center of width

- * **Minimum Inside Diameter:** 3" (76.2 mm)
- * **Minimum Width:** 1-1/2" (38.1 mm)
- * **Post Terminals:** 10-32 or 8-32
- * **Maximum Volts/Amps:** 480VAC/ 25A (10-32) or 20A (8-32) each half

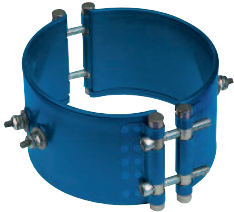

One-Piece Expandable Band

Standard Termination Location:
two sets of terminals opposite the gap; center of the width

- * **Minimum Inside Diameter:** 2-1/2" (63.5 mm)
- * **Minimum Width:** 1-1/2" (38.1 mm)
- * **Post Terminals:** 10-32 or 8-32
- * **Maximum Volts/Amps:** 480VAC/ 25A (10-32) or 20A (8-32) each half



Mi-Plus Type T3X — Screw Terminals

One-Piece Band

Standard Termination Location:
opposite the gap; across center of width

- * **Minimum Inside Diameter:** 2-1/2" (63.5 mm)
- * **Minimum Width:**
with 10-32 Post Terminals — 2-1/2" (63.5 mm)
with 8-32 Post Terminals — 2" (50.8 mm)
- * **Maximum Volts/Amps:** 480VAC/ 25A (10-32) or 20A (8-32) each half



One-Piece Expandable Band

Standard Termination Location:
two sets of terminals opposite the gap; across center of width

- * **Minimum Inside Diameter:** 2-1/2" (63.5 mm)
- * **Minimum Width:**
w/ 10-32 Post Terminals — 2-1/2" (63.5 mm)
w/ 8-32 Post Terminals — 2" (50.8 mm)
- * **Maximum Volts/Amps:** 480VAC/ 25A (10-32) or 20A (8-32) each half



Two-Piece Band

Standard Termination Location:
center of each half; across center of width

- * **Minimum Inside Diameter:** 3" (76.2 mm)
- * **Minimum Width:**
w/ 10-32 Post Terminals — 2-1/2" (63.5 mm)
w/ 8-32 Post Terminals — 2" (50.8 mm)
- * **Maximum Volts/Amps:** 480VAC/ 25A (10-32) or 20A (8-32) each half



Type T3Y — Screw Terminals, Next To Gap

Two-Piece Band

Standard Termination Location:

next to same gap on each half; across center of width

- * **Minimum Inside Diameter:** 3" (76.2 mm)
- * **Minimum Width:** with 8-32 Post Terminals — 2" (50.8 mm)
with 10-32 Post Terminals — 2-1/2" (63.5 mm)
- * **Maximum Volts:** 480VAC each half
- * **Maximum Amps:** 25A (10-32) or 20A (8-32) each half



Note: Type T3Y is not available on One-Piece or One-Piece Expandable Mi-Plus Band Heaters

Optional Igloo™ Ceramic Covers for Heaters with Screw Terminals

Igloo™ ceramic terminal covers consist of two individual ceramic parts. With a tight-fitting cap and a solid base, an Igloo will fully insulate any standard #8 or #10 terminal lug used for electrical wiring hookups. Igloos can be assembled onto any standard Mi-Plus Band with 8-32 or 10-32 screw terminals. Igloo Double Port 90° are recommended on expandable heaters with Type T3X Termination. Igloo Double Port In-Line will not fit on expandable heaters with Type T3X termination.

Exposed electrical wiring on band heater installations is a violation of Electrical Safety Codes including O.S.H.A.

Minimum Inside Diameter: 2-1/2" (63.5 mm)

Minimum Width: 2-1/2" (63.5 mm)

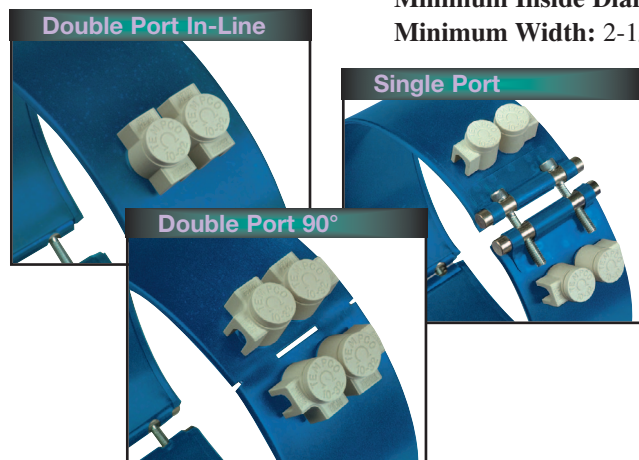

Three types of Igloo™ bases are available:

- Type C6** — Double Port In-Line P/N CER-101-104
- Type C7** — Double Port 90° P/N CER-101-106
- Type C8** — Single Port P/N CER-101-107

Igloo™ caps are available in the three crew terminal sizes:

- 10-32** — P/N CER-102-101
- 10-24** — P/N CER-102-104
- 8-32** — P/N CER-102-105

When ordering, specify the type of Igloo and the screw terminal size.

Selection
TERMINATION
Guide

Mi-Plus® Type W1 — Abrasion Resistant Straight Wire Braid Leads

The lead wires exit straight out through a stainless steel eyelet. Flexible stainless steel wire braid leads are highly recommended for improved abrasion resistance. Wire braid leads offer sharp bending not possible with armor cable.

This stainless steel braid is loosely wrapped around two mica insulated lead wires rated for 842°F (450°C). The standard leads are 10" of stainless steel loose wire braid over 12" of flexible leads. *If longer leads are required, specify when ordering.*

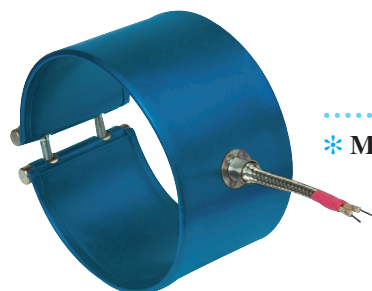

One-Piece Band

Standard Termination Location:
opposite the gap; center of width

- * **Minimum Inside Diameter:** 1" (25.4 mm)
- * **Minimum Width:** 1" (25.4 mm)
- * **Maximum Volts:** 480VAC.
- * **Maximum Amps:** 12.5

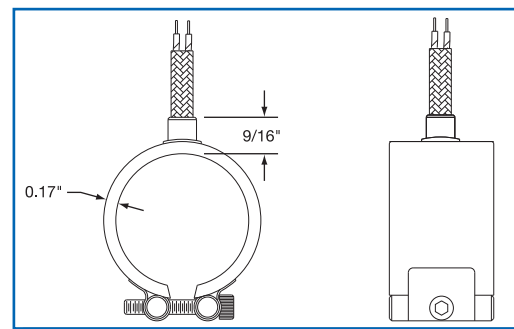

CONTINUED

Terminations

Mi-Plus® Type W1 — Abrasion Resistant Straight Wire Braid Leads

Continued from previous page...

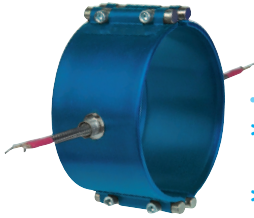

Two-Piece Band

Standard Termination Location:
center of each half; center of width

- * **Minimum Inside Diameter:**
3" (76.2 mm)
- * **Minimum Width:** 1" (25.4 mm)
- * **Maximum Volts:** 480VAC each half
- * **Maximum Amps:** 12.5A each half

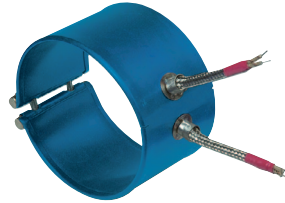

One-Piece Expandable Band

Standard Termination Location:
two sets of leads opposite the gap;
center of width

- * **Minimum Inside Diameter:**
2-1/2" (63.5 mm)
- * **Minimum Width:** 1-1/2" (38.1 mm)
- * **Maximum Volts/Amps:**
480VAC/12.5A each half

Mi-Plus Type W2 — Right-Angle Wire Braid Leads, 90 Degrees to Heater Diameter

This style of wiring is the most prevalent for nozzle band heaters, as it contributes to the most flexible and space saving installation. Mica insulated lead wires rated for 842°F (450°C) with tightly wrapped stainless steel overbraid are used, providing protection in abrasive environments. The stainless steel braid exits parallel to the heater centerline through a low profile stainless steel cap. This cap also acts as a strain relief, guarding against excessive flexing or pulling of the lead wire.

This termination style is located 180° from the gap for one-piece heaters and 90° from the gap for two-piece heaters and exits the heater near the edge. By keeping the lead wires away from the heater, less damage from high temperature contact is likely to occur.

The standard leads are 10" of stainless steel wire braid over 12" of flexible leads. *If longer leads are required, specify when ordering.*

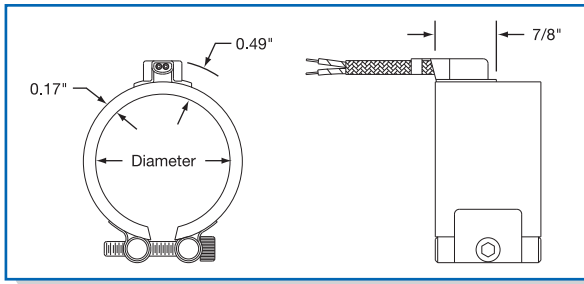

LOW PROFILE

ABRASION RESISTANT

LEAD TERMINATIONS

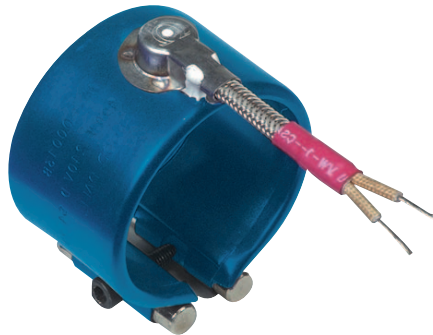

One-Piece Band

Standard Termination Location:
opposite the gap; near edge of width

- * **Minimum Inside Diameter:** 1" (25.4 mm)
- * **Minimum Width:** 1" (25.4 mm)
- * **Maximum Volts:** 480VAC
- * **Maximum Amps:** 12.5

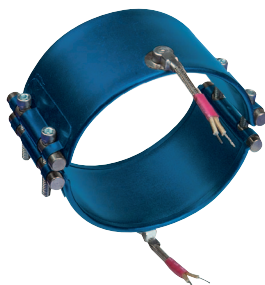

Two-Piece Band

Standard Termination Location:
center of each half; near edge of width

- * **Minimum Inside Diameter:**
3" (76.2 mm)
- * **Minimum Width:** 1" (25.4 mm)
- * **Maximum Volts/Amps:**
480VAC/12.5A each half



One-Piece Expandable Band

Standard Termination Location:
two sets of leads opposite the gap;
center of width

- * **Minimum Inside Diameter:**
3" (76.2 mm)
- * **Minimum Width:** 1" (25.4 mm)
- * **Maximum Volts/Amps:**
480VAC/12.5A each half

Mi-Plus® Type W5 — Right-Angle Wire Braid Leads, 90 Degrees to Heater Width

The stainless steel braid exits parallel to the heater surface through a low profile stainless steel cap, which also acts as a strain relief guarding against excessive flexing or pulling of the lead wire. Mica insulated lead wires rated for 842°F (450°C) with tightly wrapped stainless steel over-braid are used, providing protection in abrasive environments.

This low-profile termination is convenient where space limitations are a concern.

The standard leads are 10" of stainless steel wire braid over 12" of flexible leads. *If longer leads are required, specify when ordering.*

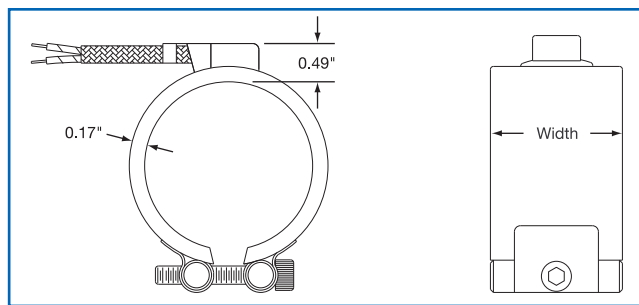

One-Piece Band

Standard Termination Location:
opposite the gap; center of width

- * Minimum Inside Diameter: 1" (25.4 mm)
- * Minimum Width: 1" (25.4 mm)
- * Maximum Volts: 480VAC
- * Maximum Amps: 12.5



Two-Piece Band

Standard Termination Location:
center of each half; center of width

- * Minimum Inside Diameter: 3" (76.2 mm)
- * Minimum Width: 1" (25.4 mm)
- * Maximum Volts: 480VAC each half
- * Maximum Amps: 12.5 each half

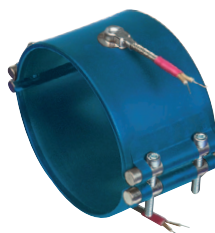

One-Piece Expandable Band

Standard Termination Location:
two sets of leads opposite the gap; center of width

- * Minimum Inside Diameter: 3" (76.2 mm)
- * Minimum Width: 1" (25.4 mm)
- * Maximum Volts/Amps: 480VAC/12.5A each half



Selection TERMINATION Guide

Mi-Plus Type R1 — Abrasion Resistant Straight Armor Cable

Stainless steel armor cable provides vastly superior lead wire protection in cases where abrasion is a constant problem. The lead wires are mica insulated and rated for 842°F (450°C).

The standard leads are 10" of stainless steel armor cable over 12" lead wire.

If longer leads are required, specify when ordering.

One-Piece Band

Standard Termination Location:
opposite the gap; center of width

- * Minimum Inside Diameter: 1" (25.4 mm)
- * Minimum Width: 1" (25.4 mm)
- * Maximum Volts: 480VAC
- * Maximum Amps: 12.5

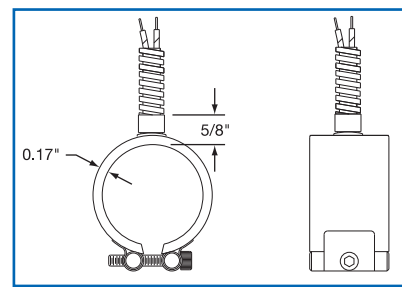
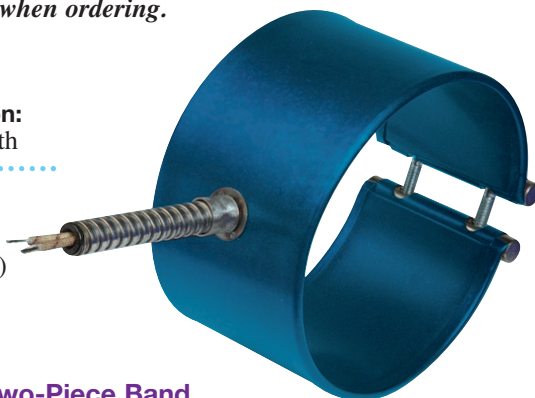

Two-Piece Band

Standard Termination Location:
center of each half; center of width

- * Minimum Inside Diameter: 3" (76.2 mm)
- * Minimum Width: 1" (25.4 mm)
- * Maximum Volts/Amps: 480VAC/12.5A each half

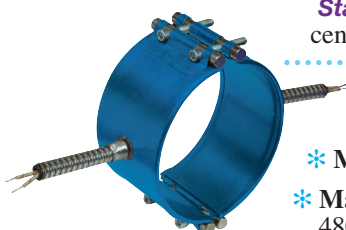

One-Piece Expandable Band

Standard Termination Location:
two sets of leads opposite the gap;
center of width

- * Minimum Inside Diameter: 2-1/2" (63.5 mm)
- * Minimum Width: 1-1/2" (38.1 mm)
- * Maximum Volts/Amps: 480VAC/12.5A each half

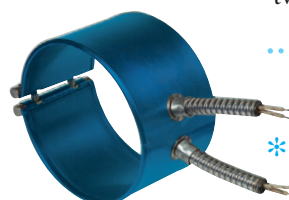

Terminations

Mi-Plus® Type R2B — Abrasion Resistant Right-Angle Armor Cable

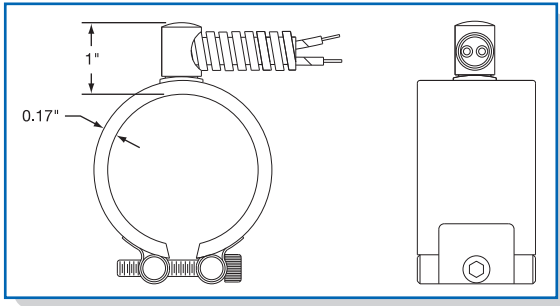

One-Piece Band

Standard Termination Location:
opposite the gap; center of width

- * **Minimum Inside Diameter:**
1" (25.4 mm)
- * **Minimum Width:** 1" (25.4 mm)
- * **Maximum Volts/Amps:**
480VAC/12.5A

Stainless Steel Right-Angle Armor Cable will provide excellent lead wire protection. This space saving termination will give long-term abrasion protection. The lead wires are mica insulated and rated for 842°F (450°C).

The standard leads are 10" of stainless steel armor cable over 12" of lead wire.
If longer leads are required, specify when ordering.

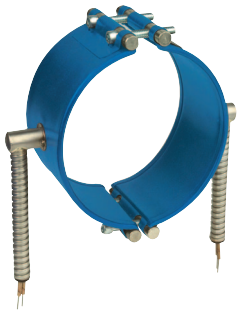

Two-Piece Band

Standard Termination Location:
center of each half; center of width

- * **Minimum Inside Diameter:**
3" (76.2 mm)
- * **Minimum Width:** 1" (25.4 mm)
- * **Maximum Volts/Amps:**
480VAC/12.5A each half

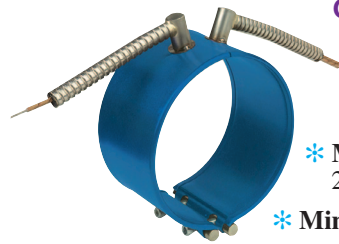

One-Piece Expandable Band

Standard Termination Location:
two sets of leads opposite the gap;
center of width

- * **Minimum Inside Diameter:**
2-1/2" (63.5 mm)
- * **Minimum Width:** 1-1/2" (38.1 mm)
- * **Maximum Volts/Amps:**
480VAC/12.5A each half

Mi-Plus Type R2H — Abrasion Resistant Right-Angle Armor Cable for Type HTL Lead Wire

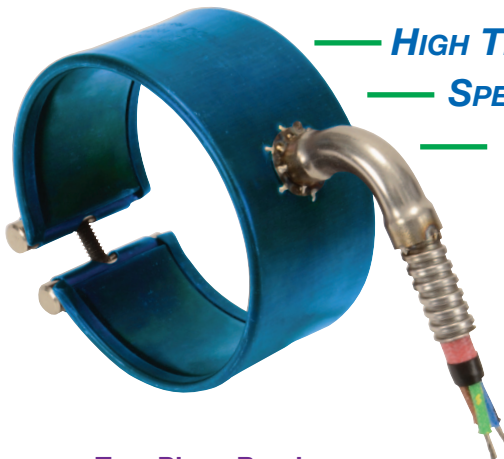
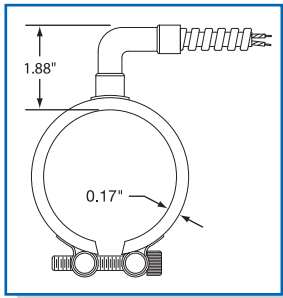

— HIGH TEMPERATURE TERMINATION: 1022°F (550°C)

— SPECIAL SS RIGHT-ANGLE FITTING

— 3-CONDUCTOR WIRE

One-Piece Band

Standard Termination Location:
opposite the gap; center of width

- * **Minimum Inside Diameter:** 1-1/2" (38.1 mm)
- * **Minimum Width:** 1" (25.4 mm)
- * **Maximum Volts/Amps:** 480VAC/12.5A

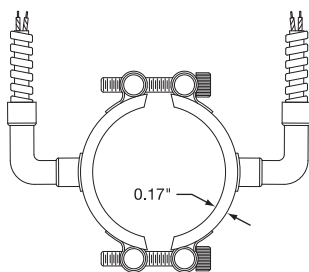

Two-Piece Band

Standard Termination Location:
center of each half;
center of width

- * **Minimum Inside Diameter:**
3" (76.2 mm)
- * **Minimum Width:**
1" (25.4 mm)
- * **Maximum Volts/Amps:**
480VAC/12.5A each half

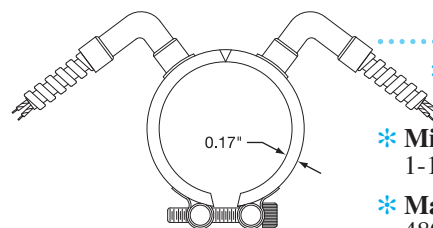

One-Piece Expandable Band

Standard Termination Location:
two sets of leads opposite the gap;
center of width

- * **Minimum Inside Diameter:**
2-1/2" (63.5 mm)
- * **Minimum Width:**
1-1/2" (38.1 mm)
- * **Maximum Volts/Amps:**
480VAC/12.5A each half

Mi-Plus® Type C — General Purpose Terminal Box

General purpose terminal boxes are a simple & economical way to protect employees from electric shock or prevent electric shorts that can result from exposed wiring on band heater electrical installations.

The Heavy Duty Stainless Steel Terminal Box has a 1/2" trade size knockout (actual diameter 7/8") that will accept standard armor cable connectors. To simplify installation, Mi-Plus band heaters with terminal boxes can be pre-wired.

Type CA – Box only (shown)

Type CD – Box with prewired SS wire braid

Type CC – Box with prewired SS armor cable

Type CE – Box with prewired plain leads

The standard abrasive protection leads are 10" of protection over 12" of flexible leads. The standard lead length for plain leads is 10" long.

If longer leads are required, specify when ordering.

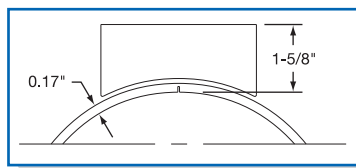

Box: One-Piece Expandable Construction

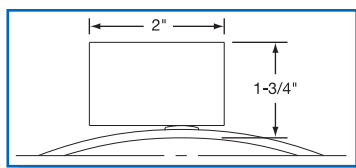

Box: One-Piece & Two-Piece Construction



One-Piece Band

Standard Termination Location: opposite the gap; center of width

- * **Minimum Inside Diameter:** 3" (76.2 mm)
- * **Minimum Width:** 2" (50.8 mm)
- * **Maximum Volts/Amps:** 480VAC/25A

Two-Piece Band

Standard Termination Location: center of each half; center of width

- * **Minimum ID:** 3" (76.2 mm)
- * **Minimum Width:** 2" (50.8 mm)
- * **Maximum Volts/Amps:** 480VAC/25A each half



One-Piece Expandable Band

Standard Termination Location: opposite the gap; center of width

- * **Minimum ID:** 3" (76.2 mm)
- * **Minimum Width:** 2" (50.8 mm)
- * **Maximum Volts/Amps:** 480VAC/25A each half

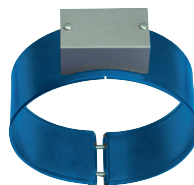

Selection TERMINATION Guide

Mi-Plus Type L1 — Plain Wire Leads

Plain wire leads are available on all construction styles. The lead wires exit straight out through a stainless steel eyelet. High-temperature 842°F (450°C) mica insulated lead wire is standard.

The standard lead length is 10" long. *If longer leads are required, specify when ordering.*

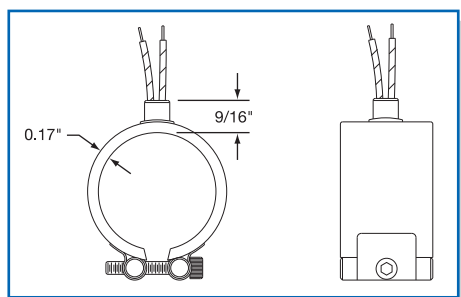

Two-Piece Band

Standard Termination Location: center of each half; center of width

- * **Minimum Inside Diameter:** 3" (76.2 mm)
- * **Minimum Width:** 1" (25.4 mm)
- * **Maximum Volts/Amps:** 480VAC/12.5A each half

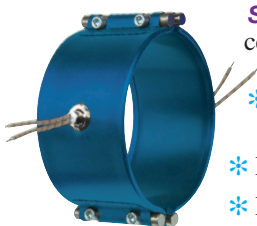

Note: Plain wire leads do not offer protection against contamination or abrasion.

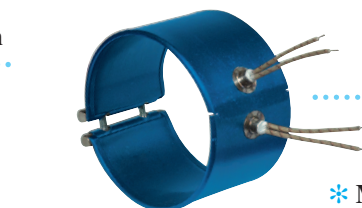

One-Piece Band

Standard Termination Location: opposite the gap; center of width

- * **Minimum Inside Diameter:** 1" (25.4 mm)
- * **Minimum Width:** 1" (25.4 mm)
- * **Maximum Volts/Amps:** 480VAC/12.5A

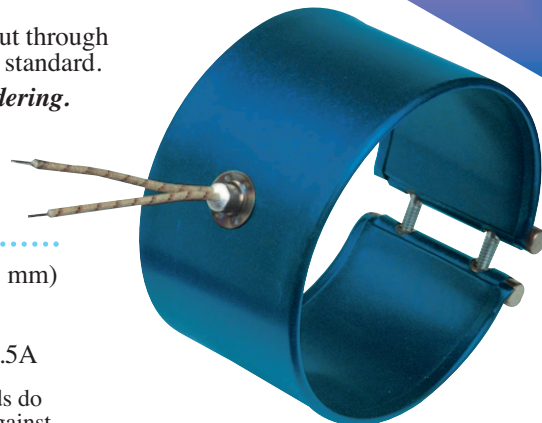

One-Piece Expandable Band

Standard Termination Location: two sets of leads opposite the gap; center of width

- * **Minimum Inside Diameter:** 2-1/2" (63.5 mm)
- * **Minimum Width:** 1-1/2" (38.1 mm)
- * **Maximum Volts/Amps:** 480VAC/12.5A each half

Mi-Plus® Type P1 — Quick Disconnect Plugs

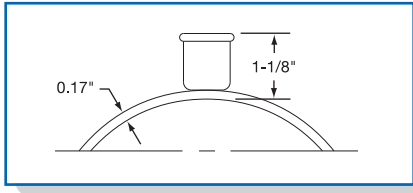

Cup Assembly Only

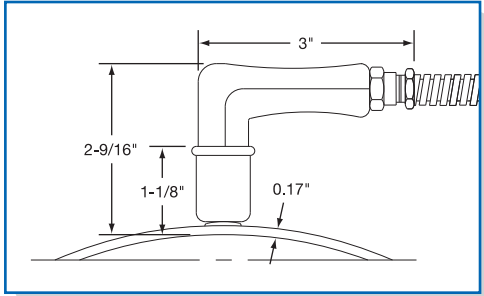

Cup Assembly with 90° Plug

Quick Disconnect Plugs are a simple, safe and quick way to apply power to a band heater installation. The combination of plug and cup assembly along with stainless steel armor cable or stainless steel wire braid eliminates all live exposed terminals or wiring that can be a potential hazard. The assembly is available with a straight or right-angle plug. To simplify installation, Mi-Plus band heaters with Quick Disconnects can be pre-wired with stainless steel armor or stainless steel wire braid.

P1A — Cup Assembly only

P1B — Cup Assembly with straight plug

P1C — Cup Assembly with 90° plug

P1E — Cup Assembly with straight plug and stainless steel armor cable

P1F — Cup Assembly with straight plug and stainless steel wire braid

P1H — Cup Assembly with 90° plug and stainless steel armor cable

P1J — Cup Assembly with 90° plug and stainless steel wire braid

The standard abrasive protection leads are 10" of protection over 12" of flexible leads. *If longer leads, armor cable or braid are required, specify when ordering.*

Type P1A Shown



One-Piece Band

Standard Termination Location:
opposite the gap; center of width

- * Minimum Inside Diameter: 3" (76.2 mm)
- * Minimum Width: 2" (50.8 mm)
- * Maximum Volts: 250VAC
- * Maximum Amps: 16
- * Maximum Temperature: 392°F (200°C)

Type P1H Shown

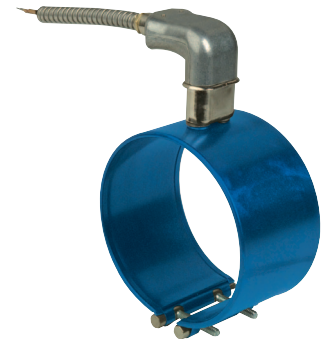

Type P1A Shown



Two-Piece Band

Standard Termination Location:
center of each half; center of width

- * Minimum Inside Diameter: 3" (76.2 mm)
- * Minimum Width: 2" (50.8 mm)
- * Maximum Volts: 250VAC each half
- * Maximum Amps: 16 each half
- * Maximum Temperature: 392°F (200°C)

Type P1H Shown

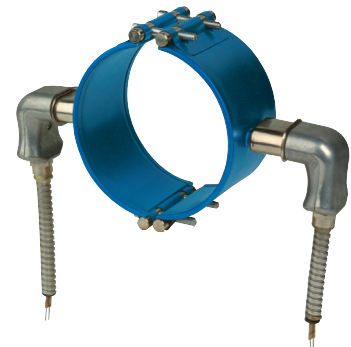

Note: Type P1 is not available on One-Piece Expandable Mi-Plus Band Heaters

Mi-Plus® Type P2 — Terminal Box and High Temperature Quick Disconnect Straight Plug

This lower profile terminal box and high temperature quick disconnect plug assembly offers a solution where clearance is a problem. The combination of plug and cup assembly along with stainless steel armor cable or stainless steel wire braid eliminates all live exposed terminals or wiring that can be a potential hazard.

The assembly is available with straight plug only. To simplify installation, Mi-Plus band heaters with Quick Disconnects can be pre-wired with stainless steel armor or stainless steel wire braid.

P2A — Box and Cup only

P2B — Box and Cup with straight plug

P2D — Box and Cup with straight plug and stainless steel armor cable

P2E — Box and Cup with straight plug and stainless steel wire braid

The standard abrasive protection leads are 10" of protection over 12" of flexible leads.

If longer leads, armor cable or braid are required, specify when ordering.

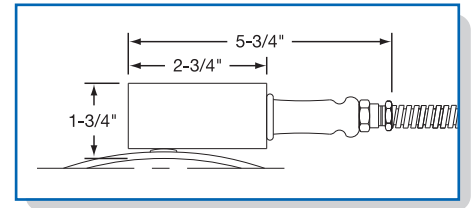

Box – One- & Two-Piece Construction

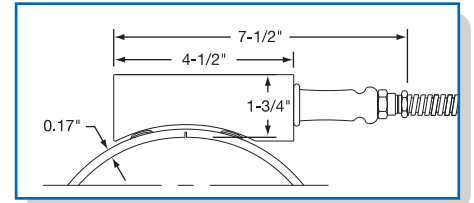

Box – One-Piece Expandable Construction

One-Piece Band

Standard Termination Location:
opposite the gap; center of width

Type P2D Shown



- * **Minimum Inside Diameter:** 3" (76.2 mm)
- * **Minimum Width:** 2" (50.8 mm)
- * **Maximum Volts:** 250VAC
- * **Maximum Amps:** 16
- * **Maximum Temperature:** 572°F (300°C)

Type P2A Shown



Selection
TERMINATION
Guide

Two-Piece Band

Standard Termination Location:
center of each half; center of width

Type P2D Shown

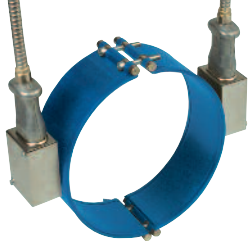

- * **Minimum Inside Diameter:** 3" (76.2 mm)
- * **Minimum Width:** 2" (50.8 mm)
- * **Maximum Volts:** 250VAC each half
- * **Maximum Amps:** 16 each half
- * **Maximum Temperature:** 572°F (300°C)

Type P2A Shown



Type P2D Shown

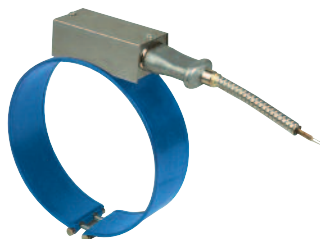

One-Piece Band Expandable

Standard Termination Location:
opposite the gap; center of width

- * **Minimum Inside Diameter:** 3" (76.2 mm)
- * **Minimum Width:** 2" (50.8 mm)
- * **Maximum Volts:** 250VAC each half
- * **Maximum Amps:** 16 each half
- * **Maximum Temperature:** 572°F (300°C)

Type P2A Shown



Mi-Plus® Type P2 — Terminal Box and Quick Disconnect Straight Plug

This lower profile terminal box and quick disconnect plug assembly offers a solution where clearance is a problem. The combination of plug and cup assembly along with stainless steel armor cable or stainless steel wire braid eliminates all live exposed terminals or wiring that can be a potential hazard.

The assembly is available with straight plug only. To simplify installation, Mi-Plus band heaters with Quick Disconnects can be pre-wired with stainless steel armor or stainless steel wire braid.

- P2A** — Box and Cup only
- P2B** — Box and Cup with straight plug
- P2D** — Box and Cup with straight plug and stainless steel armor cable
- P2E** — Box and Cup with straight plug and stainless steel wire braid

The standard abrasive protection leads are 10" of protection over 12" of flexible leads.

If longer leads, armor cable or braid are required, specify when ordering.

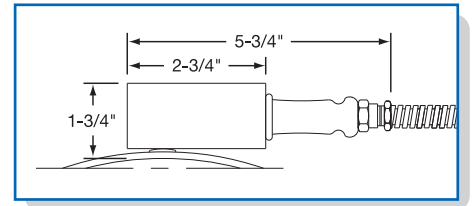

Box – One- & Two-Piece Construction

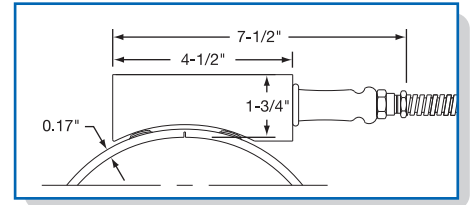

Box – One-Piece Expandable Construction

One-Piece Band

Standard Termination Location:
opposite the gap; center of width

Type P2D Shown

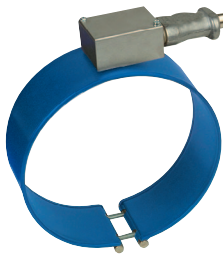

- * **Minimum Inside Diameter:** 3" (76.2 mm)
- * **Minimum Width:** 2" (50.8 mm)
- * **Maximum Volts:** 250VAC
- * **Maximum Amps:** 16
- * **Maximum Temperature:** 392°F (200°C)

Type P2A Shown



Selection
TERMINATION
Guide

Two-Piece Band

Standard Termination Location:
center of each half; center of width

Type P2D Shown

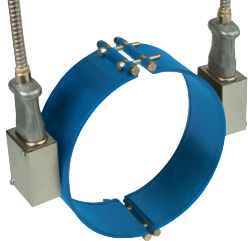

- * **Minimum Inside Diameter:** 3" (76.2 mm)
- * **Minimum Width:** 2" (50.8 mm)
- * **Maximum Volts:** 250VAC each half
- * **Maximum Amps:** 16 each half
- * **Maximum Temperature:** 392°F (200°C)

Type P2A Shown



Type P2D Shown

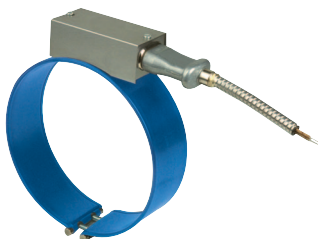

One-Piece Band Expandable

Standard Termination Location:
opposite the gap; center of width

- * **Minimum Inside Diameter:** 3" (76.2 mm)
- * **Minimum Width:** 2" (50.8 mm)
- * **Maximum Volts:** 250VAC each half
- * **Maximum Amps:** 16 each half
- * **Maximum Temperature:** 392°F (200°C)

Type P2A Shown



Installation RECOMMENDATIONS

1. Disconnect electric power to the machine and/or heaters prior to installing or replacing heaters.
2. Do not install heaters in areas where combustible gases, vapor, or dust is present.
3. Use as many narrow band heaters as the application will permit; 2" through 3" wide heaters are recommended.
4. Using a heater that closely matches the wattage requirements will decrease the frequency of cycling and temperature overshoot, thereby increasing the life of the heater.
5. Make certain that all barrel surfaces are clean and have a smooth finish. Any contaminants or imperfections on the surface can cause premature heater failure.
6. Tempco expandable type Mi-Plus Band Heaters may be opened once at the gap, to fit on the barrel. Do not open these heaters beyond their specified heater diameter.



Do not open Tempco One-Piece Non-Expandable Type Mi-Plus Band Heaters. Opening of these heaters can damage Mi-Plus Insulation and will create electrical short circuits.

7. Position heater bands on the barrel.
8. Securely tighten heater bands around the barrel. Clamping force must be equally distributed on heaters with more than one set of clamping brackets.
*Recommended Clamping Bolt Torque:
50-60 in./lbs.*
9. For heaters with screw terminals, remove the top nut and flat washers from the power screw terminals. Do not remove or loosen the bottom nut on the power screw terminals. The bottom nut is pre-torqued at our factory. A loose bottom nut will create an internal high resistance connection and will result in premature heater failure.

Installation Accessories Available

IMMEDIATE DELIVERY!

- * High Temperature Terminal Lugs
- * Igloo Ceramic Insulating Covers
- * UL Listed Plugs
- * High Temperature Lead Wire 842°F (450°C)
- * Armor Cable
- * Stainless Steel Braid
- * High Temperature Sleeving
- * High Temperature Mica Insulated Wiring Harnesses 842°F (450°C)
- * High Temperature Mica Insulated Wiring Harnesses 1022°F (550°C)
- * Thermocouples
- * Temperature Controllers
- * High Temperature Fiberglass Tape

All Items Available from Stock

10. All electrical wiring of heater bands should be done by a qualified electrician.
 - a. Use only Stainless Steel or other high temperature lugs to prevent material degradation when exposed to high temperatures over a prolonged period of time.



DO NOT USE COPPER OR PLATED COPPER LUGS.

- b. Use an open ended wrench to hold bottom nut as the wiring nut is torqued.
 - c. Heaters must be wired using the proper gauge wire with a minimum temperature rating of 842°F (450°C). All Mi-Plus Heaters supplied with lead wire terminations or factory pre-wired screw terminals use mica insulated lead wires rated to 842°F (450°C).



Never allow lead wires to lie directly on the heater surface.

- d. When connecting power leads to screw terminals make certain that barrels of terminal lugs are not facing down toward the heater case, which will create a short circuit.

*Recommended Screw Terminal Torque:
25 in./lbs.*

- e. Make certain power lead wires do not make contact with hot heater surfaces to avoid degradation of lead wire, as this can cause electrical short circuits.
 - f. Make sure the voltage input to the heater bands does not exceed the voltage rating that is stamped on the heater bands.
 - g. It is recommended that an amperage reading is taken for each heater to verify proper wiring. (Amps = Watts/Volts)
11. Insulate all live electrical wires per applicable safety standards.
12. Begin heater band re-tightening procedure. Be sure to wear protective gloves.
 - a. Energize heater bands and allow the heater sheath to reach 400°F. This usually takes between 3 and 5 minutes.
 - b. Turn power off and immediately re-tighten the Mi-Plus Bands to 50-60 in./lbs. Turn power on.
13. Install shrouds around the machine to meet applicable safety requirements.
14. Once installed, check surroundings to make sure that contaminants won't get on the heater while the unit is in operation. Accumulation of contaminants on heaters can cause premature heater failure.
15. Insulating blanket installations must have band heater retightening sequence (#12) completed before blanket installation. Lead wires must exit the insulation blanket as soon as possible; do not entrap lead wires between heater sheath and insulation blanket.



It is imperative that upon start-up of new machines at customer facilities, all of the aforementioned parameters are double checked by qualified field service personnel.

Exposed electrical wiring on band heater installations is a violation of Electrical Safety Codes including O.S.H.A.