

Part Number: MER90105

#57830 BOOT KIT

Used with
MER00830 & MER00831

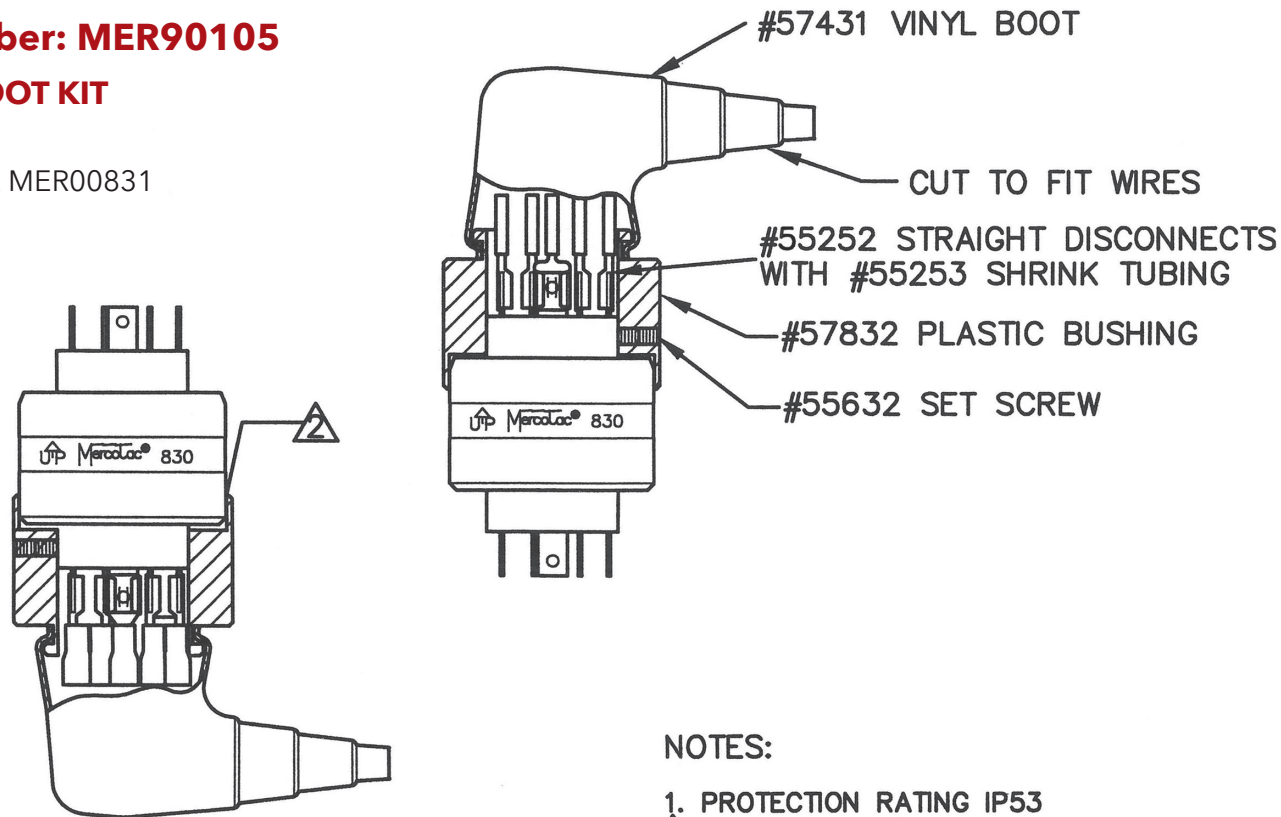

NOTES:

1. PROTECTION RATING IP53
2. IF THE MERCOTAC CONNECTOR IS MOUNTED BY THE BEARING END (WITHOUT LOAD ON THE BEARING), THEN AN IP55 RATING MAY BE OBTAINED BY CAULKING THE STATIC JOINT BETWEEN THE BUSHING & THE MERCOTAC CONNECTOR BODY.