

Tempco Flexible Heaters: Silicone Rubber & Kapton® The Answer To Hundreds of Unique Heating Applications...

Designed for Trouble-Free Performance and Improved Operation Efficiency

Tempco's Flexible Heaters are capable of operating with excellent performance under many adverse conditions, including: moisture, outdoor exposure or ambient temperatures, radiation, ozone, compression set, vacuum, fungus, oils, solvents, and many other chemicals. The low thermal mass of flexible heaters allows their use in applications where the space for placing a heater is limited and weight is a concern.

Flexible Silicone Rubber and Kapton Heaters also have very good mechanical properties. They are of low mass construction and provide rapid heat-up due to direct bonding to the part— a desired requirement for applications where precise temperature control is important to the overall quality of the application. Flexible Heaters are not affected by mechanical shock, vibration or repeated flexing and will not stretch or tear over a temperature range of -70°F to +500°F (-56.6°C to +260°C).

Select a Flexible Heater for your specific application...

Tempco Flexible Heaters are a reliable and economical heat source capable of providing uniform heat transfer to irregular shaped or flat surfaces including three dimensional geometries, conforming to the part being heated. This flexibility allows you to design a heating element literally around the shape and size of the system, machine and/or component part.

Flexible heater use typically falls into the following applications:

- * Process Heat
- * Condensation Protection
- * Freeze Protection
- * Composite Bonding

Tempco's engineering staff, with many years of experience in heat processing and temperature control, can assist you in designing the right Silicone Rubber or Kapton Flexible Heater for your application.

Tempco's Flexible Heaters offer unlimited design possibilities!

Agency



Approvals

Tempco SHS, DHR & EHR Silicone Rubber Heaters are UL Recognized in the USA and for Canada under UL File Number E65652 (UL499) Component Recognition Program, and CSA Recognized under CSA File Number 043099.

If you require UL/cUL and/or CSA Agency Approval, please specify when ordering.

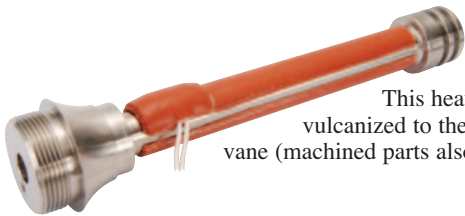

This heater, used for freeze protection, is vulcanized to the shaft in the base of a weather vane (machined parts also available from Tempco).

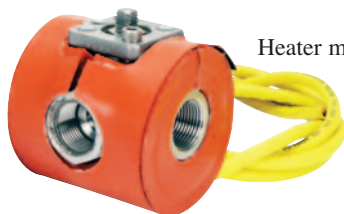

Heater manifold 3D formed for use on a snow making machine.



Heater vulcanized to black anodized aluminum for food-prep station (metal component also supplied by Tempco).

This formed heater is used to remove condensation on a vacuum canister.



Heater vulcanized to a metal plate is mounted in a refrigeration unit to minimize condensation within the control panel (metal component also supplied by Tempco).

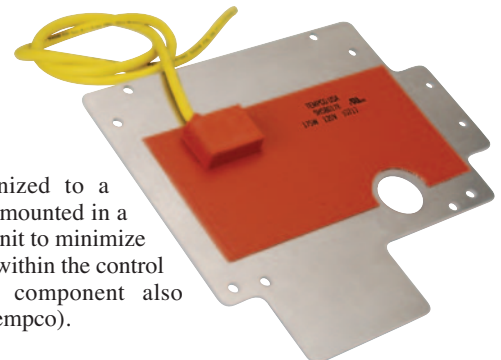

Flexible Heater Construction Characteristics

The texture of the fiberglass/silicone material can be “smooth” or “rough”. Smooth silicone tends to be more flexible and stain resistant. Rough silicone has a more durable texture. Standard construction of a plain wire-wound flexible heater is made with rough silicone. Smooth silicone is standard for heaters with PSA, vulcanized to a metal plate or other options or constructions that are deemed necessary by engineering. If smooth silicone is desired, please specify when ordering.

Flexible silicone rubber heaters can be produced using different material thicknesses and texture. Multiple layers can be applied for a thicker heater application. Overlapping the perimeter by 1/2" with the outer layers of a four-layer construction are more “moisture resistant” than standard two-layer construction giving that additional seal around the internal heater. Example: a 10" x 10" heater sandwiched between 11" x 11" outer layers.

The internal heat distribution pattern(s) allows for the heater element wire to be placed as close as 5/32" from the edge of the flexible heater. The heat pattern can be distributed to accommodate holes or cutouts, or to concentrate the heat in specific sections of the flexible heater as the application dictates.

Flexible heaters are produced in two heating element choices: wire-wound elements and etched foil elements (see page 9-4).

Typical Applications

- Aerospace
- Air Horns
- Aircraft Comfort Heaters
- Airplane Propeller Repair
- Animal Feeders
- ATM Machines
- Autoclaves
- Automotive
- Battery Heaters
- Computer Memory Planes
- Copy Machines
- Credit Card Scanners
- De-Icing
- Drum Heaters
- Food Service Equipment
- Graphic Arts Equipment
- Guidance Systems
- Gyroscopes
- Heated Presses
- Incubators
- Laboratory Equipment
- Laminators
- Liquid Reservoirs
- Medical Equipment
- Mirror Heaters
- Optical Equipment
- Outdoor Antennas
- Packaging Machinery
- Photo Processing
- Recovery Systems
- Refrigeration Equipment
- Security Equipment
- Semiconductor Equipment
- Shoe Machinery
- Turbine Propeller Repair
- Vacuum Chamber
- Vending Machines
- X-Ray Processing

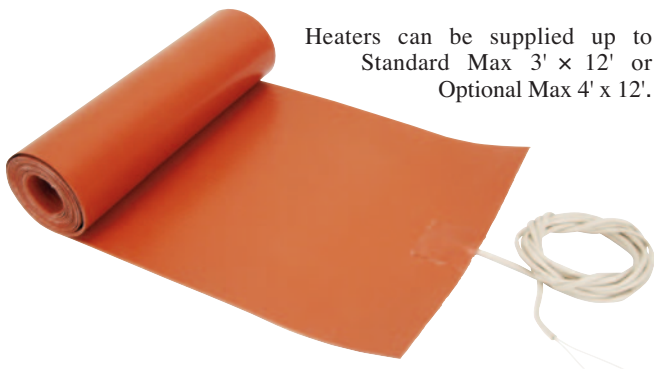

Heaters can be supplied up to
Standard Max 3' x 12' or
Optional Max 4' x 12'.

Small heater used to remove condensation in a gas filter is designed with two holes, two slits & Velcro® for easy installation while filter is in use.

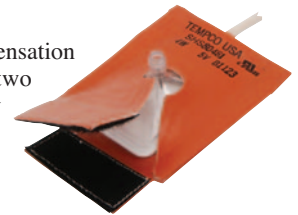

An insulating heater used on a compressor pump to prevent freezing in Siberia.

Round heater with a center hole used in air horns for motorized vehicles such as Trains, Semi Trucks, or RVs where the leads need to go through the center.



Cone heater used on a soup dispenser kettle.



Formed heater with six thermocouples for six-zone control used to refurbish airplane propellers by applying heat to cure an epoxy compound that attaches a new nickel lead edge to the propeller blade.



Standard Flexible Heater Specifications

SHS Silicone Rubber Heater Specifications

Physical Size and Construction Limitations

Maximum Size:	<i>Wire:</i> 36" × 144" (91.4 × 366 cm) <i>Foil:</i> 10" × 22" (25.4 × 56.9 cm)
Dimensional Tolerance:	
Less than 6":	±0.030" (0.76 mm)
6" to 12":	±0.060" (1.52 mm)
12" to 18":	±0.125" (3.17 mm)
18" to 36":	±0.250" (6.35 mm)
36" to 72":	±0.500" (12.7 mm)
Every 36" after 72":	Additional ±0.250" (6.35 mm)
Nominal Thickness:	<i>Wire:</i> 0.056" (1.42 mm) <i>Foil:</i> 0.030" (0.76 mm)
Available Thickness:	0.018" to 0.112" (0.46 mm to 2.85 mm)
Weight:	7 oz./ft ² (0.21g/cm ²)

Performance Ratings

Maximum Operating Temperature:	500°F / 260°C Intermittent 392°F / 200°C Continuous
Minimum Operating Temperature:	-70°F / -56.6°C
Physically Resistant To:	Moisture, Ozone, Fungus, Radiation
Agency Approvals:	UL File #E65652 (wire-wound only)

Electrical Ratings

Resistance Tolerance:	<i>Wire:</i> +10%, -5%, <i>Foil:</i> +10%, -10%
Maximum Operating Voltage:	<i>Wire:</i> 600 VAC, <i>Foil:</i> 480 VAC
Dielectric Strength:	1000 VAC
Standard Leads:	10" Teflon® Insulated Stranded Wire

SHK Kapton® Heater Specifications

Physical Size and Construction Limitations

Maximum Size:	10" × 22" (25.4 × 56.9 cm)
Dimensional Tolerance:	
Less than 6":	±0.030" (0.76 mm)
6" to 12":	±0.060" (1.52 mm)
Over 12":	±0.125" (3.17 mm)
Nominal Thickness:	0.008" (0.20 mm)
Weight:	1.5 oz./ft ² (0.05g/cm ²)

Performance Ratings

Maximum Operating Temperature:	392°F / 200°C Continuous
Minimum Operating Temperature:	-320°F / -195°C
Physically Resistant To:	Moisture, Ozone, Fungus

Electrical Ratings

Resistance Tolerance:	+10%, -10%
Maximum Operating Voltage:	480 Vac
Dielectric Strength:	1000 Vac
Standard Leads:	10" Teflon® Insulated Stranded Wire

Maximum Resistance Density for Heaters with Etched Foil Element: 125 Ω/in²



Note: Other materials are available, such as neoprene rubber or vinyl plastic. Consult Tempco for more information.

Wire-Wound Element Construction ●●●●●●●●●●

Tempco Silicone Rubber heaters with wire-wound elements provide excellent physical strength capable of withstanding repeated flexing without compromising the life and performance of the heater. They are also very effective for manufacturing geometrically challenged shapes, including three dimensional ones.

The wire-wound element process consists of resistance wire wound on a fiberglass cord for added support and flexibility. The wire-wound element is laid out in a special designed pattern to ensure uniform heat profile and to conform to the size and shape of the silicone rubber heater, avoiding holes and cutouts, or to concentrate the heat profile in a specific section(s) of the heater as the application dictates.

Power lead wires or cord sets are attached to the heater windings with solder and firmly secured in place through a vulcanizing process, ensuring that the assembly becomes homogenous.

The wire-wound process is recommended and preferred for small to medium size quantities, medium to large size heaters, and to produce prototypes to prove out the design parameters prior to entering into large volume production runs when using etched foil.

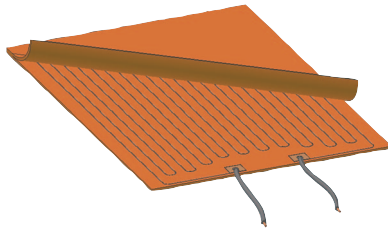

Etched Foil Element Construction ●●●●●●●●●●

Etched Foil Silicone Rubber or Kapton flexible heaters are made with a thin metal foil (.001"), usually a nickel base alloy, as the resistance element. The resistance pattern to be etched is designed in CAD and transferred to the foil, which is laminated to the insulating substrate. The element/substrate is then processed through an acid spray to produce the desired resistance pattern.

The top layer is then added and vulcanized for silicone rubber or laminated for Kapton heaters. For silicone rubber heaters, lead wires are then attached to the heater and insulated with additional silicone rubber to complete the heater. For Kapton® heaters, lead wires are attached to the heater and insulated with epoxy cement to complete the heater.

The etched foil heater has exceptional heat transfer compared to wire wound elements, due to its large flat surface area. It can deliver more uniform heat profiles with higher watt densities, providing longer operating heater life. It can also be zoned with distributed wattage or separate heating circuits to compensate for load variations. The etched foil process is recommended for small size heaters in large quantities.

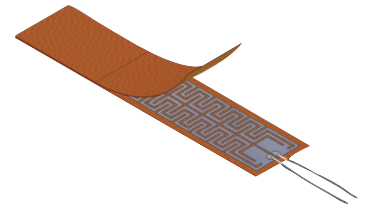

Flexible Heater Wattage Recommendations

Step 1 Determine the Required Wattage

Every process has a unique wattage requirement to heat that particular load up to temperature or to maintain a particular temperature.

If the required heater wattage is not known, estimate the required wattage using the thermodynamic formulas listed in chapter 16, Engineering. A safety factor of 25% additional wattage is recommended to compensate for unknown variables.

Example

To raise the temperature of an aluminum plate 6" x 12" x 0.5" (3.53 lb.) 200°F (from 70° to 270°F) in 0.5 hours:

$$\text{Watts} = \frac{3.53 \text{ lbs.} \times (0.24 \text{ Btu/lb.}^\circ\text{F}) \times 200^\circ\text{F}}{3.412 \text{ btu/watt hr.} \times 0.5 \text{ hrs.}} = 99 \text{ watts}$$

Add safety margin: 99 W + 25% = 124 watts

Step 2 Determine the Heater Size and Watt Density

A flexible heater should use the maximum space available for mounting and heating the process. Factors that affect heater size include the mounting method and watt density.

$$\text{Watt Density} = \frac{\text{Heater Wattage}}{\text{Area of the Heater}}$$

As a general rule, the following can be applied for silicone rubber heaters:

Low Heat-Up: 2.5 w/in²

Average Heat-Up: 5 w/in²

High Heat-Up: 7.5 w/in² and greater

Continuing the aluminum plate example, determine what size the heater should be:

Silicone Rubber Heater: 5" x 10" = 50 in²

Watt Density = 135 watts ÷ 50 in² = 2.7 watts/in²

Since the watt density falls between 2.5 and 5 w/in², the silicone rubber heater selected should work satisfactorily.

Referring to the chart below for a wire wound silicone rubber heater, pressure sensitive adhesive mounting should work well for this application at the required temperature.

If the calculated watt density is too high, a larger heater will lower the required watt density and still produce the same wattage.

Silicone Rubber Heater Surface Temperature vs. Watt Density

Graph shows the relationship between the maximum surface temperature and the watt density of standard silicone rubber heaters.

The heater was energized in still air without insulation or a load. Using this graph the designer can estimate the maximum temperature the heater can reach compared to the watt density of the heater.

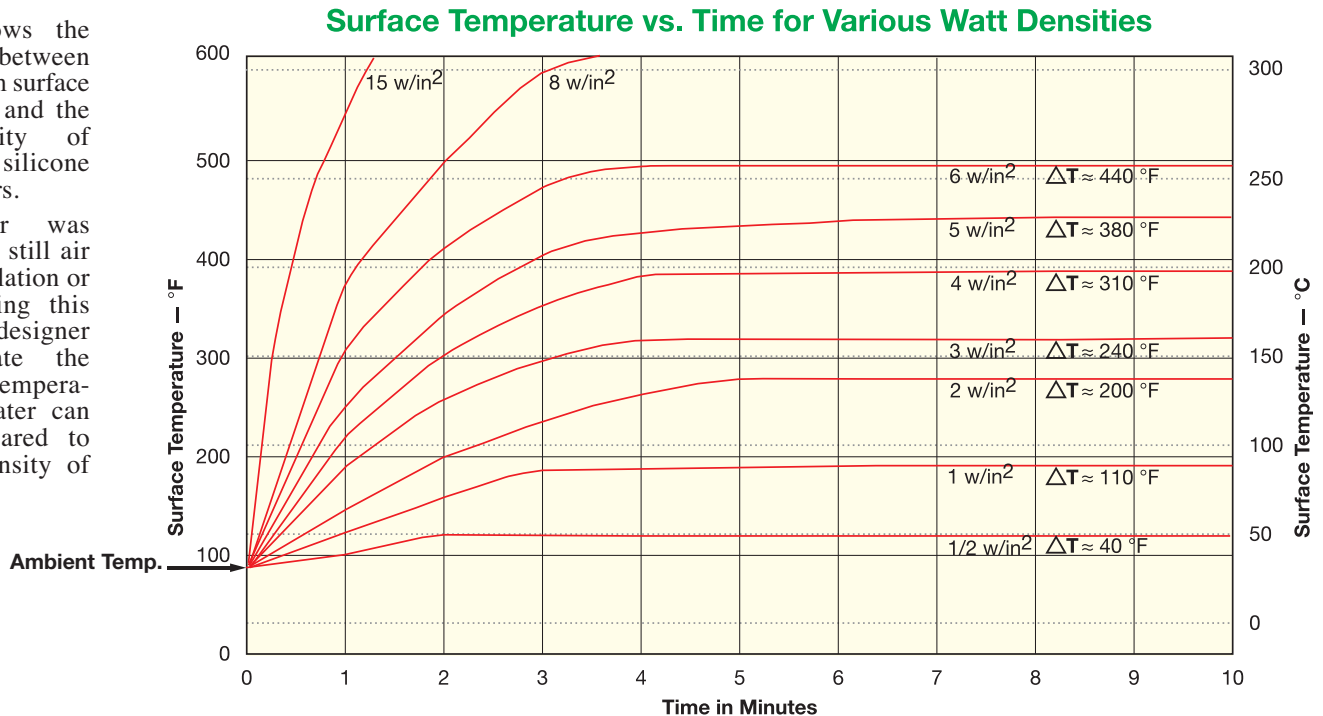

ΔT = Temperature Rise From Ambient at Specified Watt Densities

CONTINUED

Flexible Heater Wattage Recommendations

Continued from previous page...

Suggested Maximum Watt Density by Heater Type and Mounting Method

Watt Density w/in ²	Silicone Rubber – Wire Element		Silicone Rubber – Foil Element		Kapton® – Foil Element	
	Vulcanized	PSA	Vulcanized	PSA	Acrylic PSA	Acrylic PSA with 3 mil Aluminum Foil
5	420 to 356°F (216 to 180°C)	350 to 335°F (177 to 168°C)	455 to 419°F (235 to 215°C)	350 to 320°F (177 to 160°C)	212 to 189°F (100 to 87°C)	302 to 275°F (150 to 135°C)
10	356 to 266°F (180 to 130°C)	335 to 248°F (168 to 120°C)	419 to 383°F (215 to 195°C)	320 to 293°F (160 to 145°C)	189 to 163°F (87 to 73°C)	275 to 257°F (135 to 125°C)
15	266 to 158°F (130 to 70°C)	248 to 140°F (120 to 60°C)	383 to 347°F (195 to 175°C)	293 to 266°F (145 to 130°C)	163 to 131°F (73 to 55°C)	257 to 230°F (125 to 110°C)
20	158 to 68°F (70 to 20°C)	140 to 32°F (60 to 0°C)	347 to 311°F (175 to 155°C)	266 to 239°F (130 to 115°C)	131 to -25°F (55 to -32°C)	230 to 194°F (110 to 90°C)
25	68 to -40°F (20 to -40°C)	32 to -49°F (0 to -45°C)	— —	— —	— —	194 to 167°F (90 to 75°C)
30	— —	— —	311 to 257°F (155 to 125°C)	239 to 185°F (115 to 85°C)	— —	167 to 125°F (75 to 52°C)
35	— —	— —	— —	— —	— —	125 to 86°F (52 to 30°C)
40	— —	— —	257 to 185°F (125 to 85°C)	185 to 104°F (85 to 40°C)	— —	86 to -25°F (30 to -32°C)
50	— —	— —	185 to 50°F (85 to 10°C)	104 to -40°F (40 to -40°C)	— —	— —
60	— —	— —	50 to -49°F (10 to -45°C)	-40 to -49°F (-40 to -45°C)	— —	— —



Note: Use an appropriate Temperature Controller for the application.

Silicone Rubber Standard (Non-Stock) Sizes and Ratings

Silicone Rubber Heaters listed have 10" Teflon® Insulated Stranded Lead Wires exiting at Location L (see page 9-9).

Diameter in. mm	Area		Watts	Wire Construction		Foil Construction	
	in ²	cm ²		120V	240V	120V	240V
3.0	76	7.07	45.6	35	SHS00201	—	—
3.5	89	9.62	62.1	48	SHS00202	—	—
4.0	102	12.57	81.1	63	SHS00203	SHS00222	SHS00242
4.5	114	15.90	102.6	80	SHS00204	SHS00223	SHS00243
5.0	127	19.63	126.6	98	SHS00205	SHS00224	SHS00244
5.5	140	23.76	153.3	119	SHS00206	SHS00225	SHS00245
6.0	152	28.27	182.4	141	SHS00207	SHS00226	SHS00246
6.5	165	33.18	214.1	166	SHS00208	SHS00227	SHS00247
7.0	178	38.48	248.3	192	SHS00209	SHS00228	SHS00248
7.5	191	44.18	285.0	221	SHS00210	SHS00229	SHS00249
8.0	203	50.26	324.3	250	SHS00211	SHS00230	SHS00250
8.5	216	56.74	366.1	284	SHS00212	SHS00231	SHS00251
9.0	229	63.62	410.4	318	SHS00213	SHS00232	SHS00252
9.5	241	70.88	457.3	354	SHS00214	SHS00233	SHS00253
10.0	254	78.54	506.7	393	SHS00215	SHS00234	SHS00254
10.5	267	86.59	558.7	430	SHS00216	SHS00235	SHS00255
11.0	279	95.03	613.2	480	SHS00217	SHS00236	SHS00256
11.5	292	103.87	670.2	520	SHS00218	SHS00237	SHS00257
12.0	305	113.10	729.7	570	SHS00219	SHS00238	SHS00258
15.0	381	176.72	1140.2	880	SHS00220	SHS00239	SHS00259
20.0	508	314.16	2027.0	1570	SHS00221	SHS00240	SHS00260

**Silicone Rubber
Rounds**





Stock Square & Rectangular Silicone Rubber Heaters

Standard Smooth Silicone Rubber Heater

Heater with Pressure Sensitive Adhesive (PSA) Backing

Maximum Operating Temperature: 450°F (232°C)

Maximum Operating Temperature: 300°F (149°C)

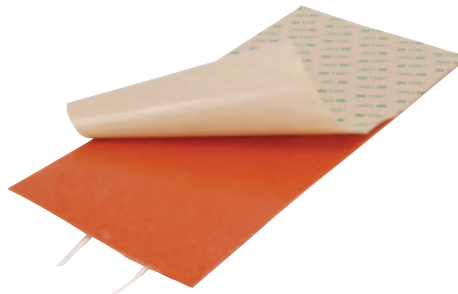

Use an appropriate method of temperature control to prevent heaters from exceeding maximum operating temperature. Reference Surface Temperature vs. Watt Density graph on page 9-5.



Stock Silicone Rubber Heaters — Standard Smooth and with Pressure Sensitive Adhesive Backing (PSA)

Silicone Rubber Heaters listed are 120 Volt and have 10" Teflon® Insulated Stranded Lead Wires exiting at Location A (see page 9-9).

Width		Length		Watts	Watt Density w/in ²	Part Number	
in.	mm	in.	mm			Standard (No PSA)	With PSA Backing
2	51	2	51	10	2.5	SHS80293	SHS80294
2	51	2	51	20	5	SHS80295	SHS80296
3	76	3	76	25	2.5	SHS80297	SHS80298
3	76	3	76	45	5	SHS80299	SHS80300
3	76	3	76	90	10	SHS80301	SHS80302
6	152	6	152	90	2.5	SHS80303	SHS80304
6	152	6	152	180	5	SHS80305	SHS80306
6	152	6	152	360	10	SHS80307	SHS80308
9	229	9	229	200	2.5	SHS80309	SHS80310
9	229	9	229	400	5	SHS80311	SHS80312
9	229	9	229	800	10	SHS80313	SHS80314
10	254	10	254	250	2.5	SHS80315	SHS80316
10	254	10	254	500	5	SHS80317	SHS80318
10	254	10	254	1000	10	SHS80319	SHS80320
12	305	12	305	360	2.5	SHS80321	SHS80322
12	305	12	305	720	5	SHS80323	SHS80324
12	305	12	305	1440	10	SHS80325	SHS80326
1	25	3	76	10	2.5	SHS80327	SHS80328
1	25	3	76	15	5	SHS80329	SHS80330
1	25	3	76	30	10	SHS80331	SHS80332
1	25	6	152	15	2.5	SHS80333	SHS80334
1	25	6	152	30	5	SHS80335	SHS80336
1	25	6	152	60	10	SHS80337	SHS80338
1	25	9	229	25	2.5	SHS80339	SHS80340
1	25	9	229	50	5	SHS80341	SHS80342
1	25	9	229	90	10	SHS80343	SHS80344
1	25	12	305	30	2.5	SHS80345	SHS80346
1	25	12	305	60	5	SHS80347	SHS80348
1	25	12	305	120	10	SHS80349	SHS80350
1	25	18	457	45	2.5	SHS80351	SHS80352
1	25	18	457	90	5	SHS80353	SHS80354
1	25	18	457	180	10	SHS80355	SHS80356
1	25	24	610	60	2.5	SHS80357	SHS80358
1	25	24	610	120	5	SHS80359	SHS80360
1	25	24	610	240	10	SHS80361	SHS80362
1	25	30	762	75	2.5	SHS80363	SHS80364
1	25	30	762	150	5	SHS80365	SHS80366
1	25	30	762	300	10	SHS80367	SHS80368

Width		Length		Watts	Watt Density w/in ²	Part Number	
in.	mm	in.	mm			Standard (No PSA)	With PSA Backing
1	25	48	1219	120	2.5	SHS80369	SHS80370
1	25	48	1219	240	5	SHS80371	SHS80372
1	25	48	1219	480	10	SHS80373	SHS80374
1	25	60	1524	150	2.5	SHS80375	SHS80376
1	25	60	1524	300	5	SHS80377	SHS80378
1	25	60	1524	600	10	SHS80379	SHS80380
1	25	72	1829	180	2.5	SHS80381	SHS80382
1	25	72	1829	360	5	SHS80383	SHS80384
1	25	72	1829	720	10	SHS80385	SHS80386
2	51	6	152	30	2.5	SHS80387	SHS80388
2	51	6	152	60	5	SHS80389	SHS80390
2	51	6	152	120	10	SHS80391	SHS80392
2	51	9	229	45	2.5	SHS80393	SHS80394
2	51	9	229	90	5	SHS80395	SHS80396
2	51	9	229	180	10	SHS80397	SHS80398
2	51	12	305	60	2.5	SHS80399	SHS80400
2	51	12	305	120	5	SHS80401	SHS80402
2	51	12	305	240	10	SHS80403	SHS80404
3	76	6	152	45	2.5	SHS80405	SHS80406
3	76	6	152	90	5	SHS80407	SHS80408
3	76	6	152	180	10	SHS80409	SHS80410
3	76	9	229	70	2.5	SHS80411	SHS80412
3	76	9	229	140	5	SHS80413	SHS80414
3	76	9	229	280	10	SHS80415	SHS80416
3	76	12	305	90	2.5	SHS80417	SHS80418
3	76	12	305	180	5	SHS80419	SHS80420
3	76	12	305	360	10	SHS80421	SHS80422
6	152	12	305	180	2.5	SHS80423	SHS80424
6	152	12	305	360	5	SHS80425	SHS80426
6	152	12	305	720	10	SHS80427	SHS80428
6	152	24	610	360	2.5	SHS80429	SHS80430
6	152	24	610	720	5	SHS80431	SHS80432
6	152	24	610	1440	10	SHS80433	SHS80434
9	229	12	305	270	2.5	SHS80435	SHS80436
9	229	12	305	540	5	SHS80437	SHS80438
9	229	12	305	1080	10	SHS80439	SHS80440
12	305	24	610	720	2.5	SHS80441	SHS80442
12	305	24	610	1440	5	SHS80443	SHS80444

(800) 323-6859 • Email: sales@tempco.com

Flexible Heaters



Standard Sizings and Ratings

Kapton® Standard (Non-Stock) Sizes and Ratings



**Kapton
Rounds**

Diameter		Area		Watts	Part Number	
in.	mm	in ²	cm ²		120V	240V
3.0	76	7.07	45.6	35	SHK00101	—
3.5	89	9.62	62.1	48	SHK00102	—
4.0	102	12.57	81.1	63	SHK00103	—
4.5	114	15.90	102.6	80	SHK00104	SHK00116
5.0	127	19.63	126.6	98	SHK00105	SHK00117
5.5	140	23.76	153.3	119	SHK00106	SHK00118
6.0	152	28.27	182.4	141	SHK00107	SHK00119
6.5	165	33.18	214.1	166	SHK00108	SHK00120
7.0	178	38.48	248.3	192	SHK00109	SHK00121
7.5	190	44.18	285.0	221	SHK00110	SHK00122
8.0	203	50.26	324.3	250	SHK00111	SHK00123
8.5	216	56.74	366.1	284	SHK00112	SHK00124
9.0	229	63.62	410.4	318	SHK00113	SHK00125
9.5	241	70.88	457.3	354	SHK00114	SHK00126
10.0	254	78.54	506.7	393	SHK00115	SHK00127

KAPTON FLEXIBLE HEATERS

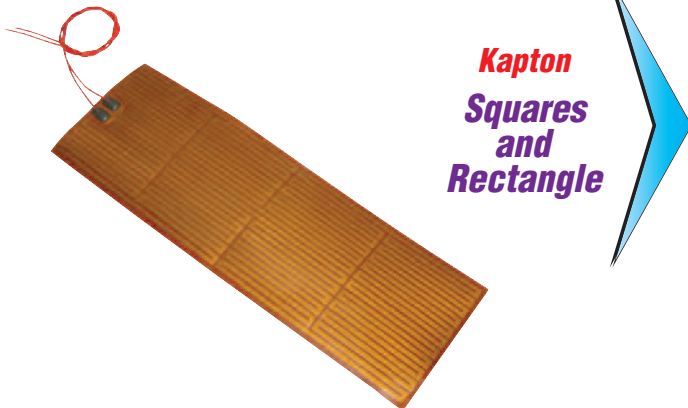

**Kapton
Squares
and
Rectangle**

Width		Length		Watts	Part Number	
in.	mm	in.	mm		120V	240V
1	25	8	203	40	SHK00001	—
1	25	12	305	60	SHK00002	SHK00022
2	51	2	51	20	—	SHK00023
2	51	4	102	40	SHK00004	SHK00024
2	51	8	203	80	SHK00005	SHK00025
2	51	12	305	120	SHK00006	SHK00026
3	76	4	102	60	SHK00007	SHK00027
3	76	8	203	120	SHK00008	SHK00028
3	76	12	305	180	SHK00009	SHK00029
4	102	4	102	80	SHK00010	SHK00030
4	102	8	203	160	SHK00011	SHK00031
4	102	12	305	240	SHK00012	SHK00032
5	127	6	152	150	SHK00013	SHK00033
5	127	10	254	250	SHK00014	SHK00034
5	127	12	305	300	SHK00015	SHK00035
6	152	6	152	180	SHK00016	SHK00036
6	152	10	254	300	SHK00017	SHK00037
6	152	12	305	360	SHK00018	SHK00038
8	203	8	203	320	SHK00019	SHK00039
8	203	12	305	480	SHK00020	SHK00040
10	254	10	254	500	SHK00021	SHK00041

Ordering Information

Catalog Heaters

Chose from the tables of common sizes of Silicone Rubber and Kapton in round or rectangular shapes.

The heaters listed are 5 W/in². Standard configuration includes 10" Teflon® leads, exit style A or L (see page 9-9) and no mounting option.

Custom Engineered/Manufactured Heaters

An electric heater can be very application specific; for sizes and ratings not listed, **TEMPCO** will design and manufacture a Flexible Surface Heater to meet your requirements. **Standard lead time is 4 to 5 weeks.**

Please Specify the following:

- Diameter
- Wattage and Voltage
- Lead Type
- Sensors or Thermostats
- Special Features or Cutouts
- Lead Location

⚠ WARNING: Cancer and Reproductive Harm - www.P65Warnings.ca.gov.

View Product Inventory @ www.tempco.com

Flexible Heater Lead End Termination Options

Tempco's standard lead termination is stripped lead ends — 1/4" (6.3mm). Any type of connector can be attached to the leads to complete the assembly and make wiring into applications quick and easy.

From simple ring crimp connectors to complex male or female crimp pins and housings such as Molex® components, Tempco does it all!

Tempco's expert designers and assemblers can also provide complete wire harnesses if required. Consult Tempco with your requirements.

Crimp Connectors: insulated or non-insulated

- Ring Terminal
- Spade Terminal
- 1/4" Female Straight Disconnect
- 1/4" Female Right-Angle Disconnect

Miniature Connectors: example – Molex

Plugs:

- Standard 120 or 240 Vac – straight blade
- Twist locking plugs, 120 to 480 Vac
- Specify NEMA or manufacturer's part number

Special Connectors and Plugs:

- Consult Tempco with your requirements.

Flexible Heater Lead Exit Location Options

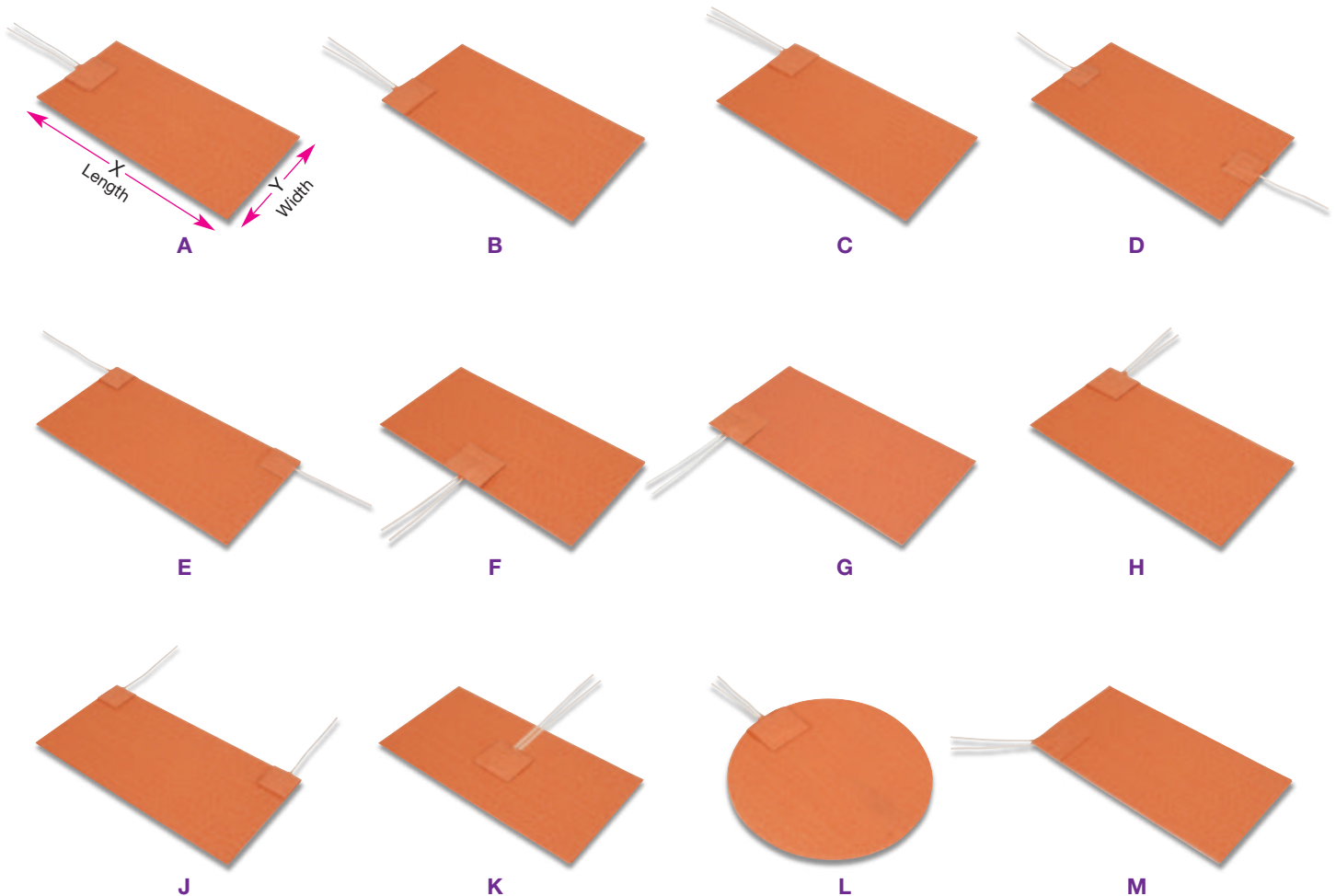

- Notes:**
1. Oriented so X is always greater than Y.
 2. Specify lead exit location using identification letters A through M.
 3. Provide a sample and/or drawing indicating power leads or cord set exit location for shapes other than those shown above.

Lead and Termination Options

Flexible Heater Lead Options

Standard Leads — Teflon®

Tempco's standard leads are 10" long, Teflon® insulated, flexible, stranded, plated copper wire. Stripped: 1/4"

- UL1180 rated 300V 200°C
- UL1199 rated 600V 200°C

On silicone rubber heaters, the lead connections are insulated with vulcanized silicone rubber, which also acts as a strain relief.

For Kapton® insulated heaters, high temperature epoxy is used to insulate and reinforce the lead connection.



Optional Leads

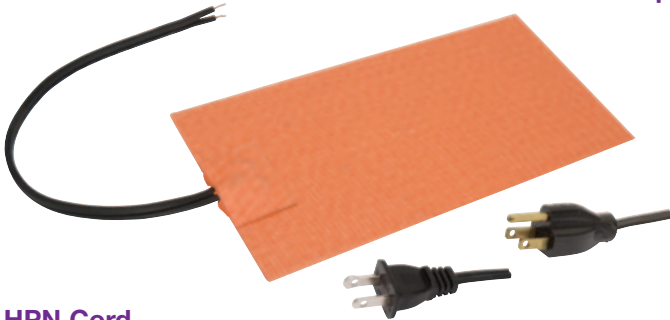

HPN Cord

For portable heaters, a two-conductor neoprene cordset can be vulcanized to the heater in any desired length.

HPN Cord and Plug Set

A two-conductor neoprene cord and plug set can be vulcanized to the heater. Standard Length: 6 ft. (1.83 M), 7 ft. (2.13M), or custom length as specified. Supplied with standard straight blade ungrounded plug, or grounded plug. 120Vac only.

- 2-Pole 2 wire non-grounding (NEMA 1-15P)
- 2-Pole 3 wire grounding (NEMA 5-15P)

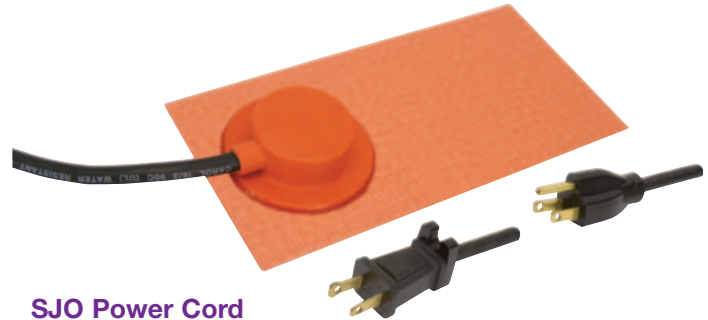

SJO Power Cord

For industrial applications, SJO heavy duty power cords can be attached to the heaters in any desired length.

SJO Power Cord and Plug Set

SJO heavy duty power cord and plug set can be attached to the heaters. Standard Length: 6 ft. (1.83 M), or custom length as specified. Supplied with standard straight blade ungrounded plug, or grounded plug. 120Vac only. (For 240Vac see page 15-15 for optional plugs)

- 2-Pole 2 wire non-grounding (NEMA 1-15P)
- 2-Pole 3 wire grounding (NEMA 5-1)



Silicone Rubber Leads

Ensures a moisture seal on the heater. Due to the similarity in material, the heater will fuse to the leads during the vulcanization process. Silicone rubber leads are more flexible, but are not as abrasion resistant as Teflon® leads.

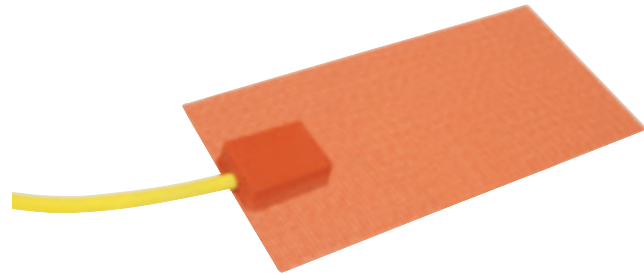

Built-Up Molded Lead Exit

Used to encase lead exit and optional snap action thermostat. (See page 9-15 for thermostat specifications) Shown with SJO cord rated -50°C to 105°C.

Special Lead Options

Special lead wire types and lengths in many configurations can be done. Consult Tempco.

Abrasion Protection Options

Various materials can be put over Teflon® or Silicone Rubber leads to provide mechanical or abrasion protection. The leads exit the heater as a single unit.

- Silicone Rubber/Fiberglass Sleeving (356°F/180°C)
- Heat Shrink Sleeving

Flexible Heater Optional Design Features



Internal Ground Screen Plane

Some applications may require the heater to be grounded. Due to the fact that the heater sheath is non-conductive, this can only be done artificially. A second layer of insulating material and a conductive grid can be added to the heater. A ground wire is attached to the grid.

A less expensive alternative for setting up a ground wire, especially for the required ground lead of a cordset, is to have a "flying ground lead" (6" long, green) exit the lead patch for attaching to the metal load surface, effectively grounding the process.

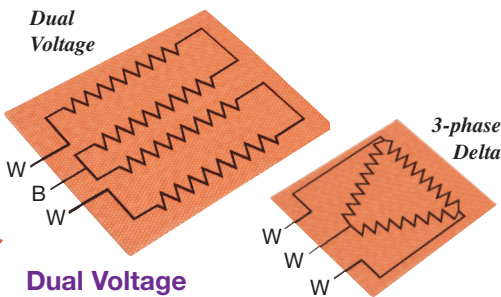

Dual Voltage

Due to the flexibility in circuit design for flexible heaters, heating circuits can be designed to accommodate dual voltage. On dual voltage heaters, three leads, including a common in a different color, are provided for wiring the heater in series for the higher voltage and parallel for the lower voltage. 120/240 Vac or 240/480 VAC can be specified (see page 16-11 for more information).

Three-Phase

Heaters can be designed with internal three-phase delta wiring. Three phase WYE wiring is also possible but less preferable in most cases. All 3-phase heaters will have three power leads coming out of the heater. Three phase heaters are typically larger heaters used in high current applications.

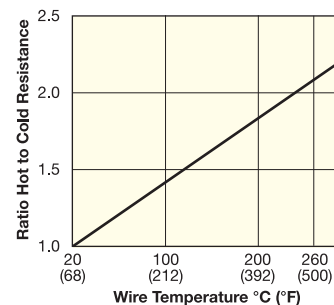

Self-Limiting/Self-Regulating Wire Wound Heater

The alloy used for this heater's resistance wire has a high positive temperature coefficient of resistance that allows the heater to reduce power as temperature increases. This self-regulating feature is ideal for many low temperature applications. This feature can also be beneficial when a fast start-up time is required before the heater power levels off to normal operating temperature. See Chart for Ratio of Hot to Cold Resistance of the Heater wire at various wire temperatures.

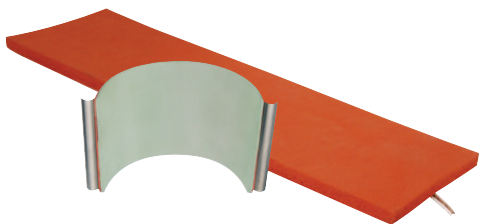

Thermal Sponge Insulation and Thermal Conductive Sponge

To increase heater efficiency, silicone sponge rubber insulation can be bonded to the top side of the heater. Available thicknesses are 1/16", 1/8", 1/4", 3/8" or 1/2".

Thermal Conductive Sponge can be used to transfer heat evenly to various surfaces. Available in 1/8" thickness.

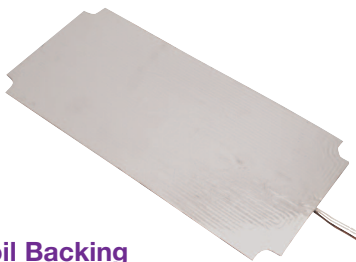

Foil Backing

Aluminum foil can be added to the back of the heater to help dissipate the heat between element runs and eliminate hot spots. Due to the foil, higher watt densities and better temperature uniformity can be attained. The foil would be applied to the back of the heater, on the mounting surface.



Distributed Wattage

In order to compensate for heating losses around the edges or mounting holes, the heating circuit can be designed in a distributed wattage pattern. More wattage can be added to the high loss areas to compensate for the higher losses.

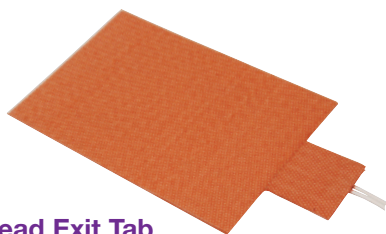

Lead Exit Tab

An unheated lead exit tab can be added to the heater for a variety of reasons such as maintaining a rectangular heater with no cold sections or when used in a compression application to remove the lead exit area from between the plates. (Standard size is 2" x 2".)

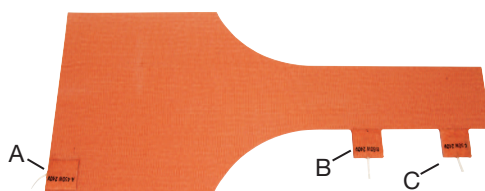

Multiple Zones

Multiple circuit areas can be zoned to compensate for various heating effects desired. In the picture above there are three zones with separate leads (A, B, & C).

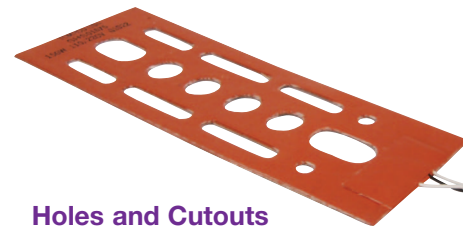

Holes and Cutouts

Holes and cutouts in the surface of a silicone rubber or Kapton® heater can generally be placed anywhere in the heater assembly. Holes and cutouts can be used to allow space for bolts, nuts, temperature sensors, brackets, etc. For most holes and cutouts, a detailed drawing will be required for quoting or ordering.

Mounting Methods

Flexible Heater Pressure Sensitive Adhesive (PSA)

PSA

For ease of attachment specify PSA. Installation is simple: just peel off the protective liner and apply. It will adhere to most clean smooth surfaces. Care must be taken when installing to attain a smooth, consistent, uniform bond to achieve maximum results.

Maximum Temperature:

Continuous – 300°F (149°C)
Intermittent – 500°F (260°C)

Recommended Watt Density:

Under 5 W/in² (0.78 W/cm²)

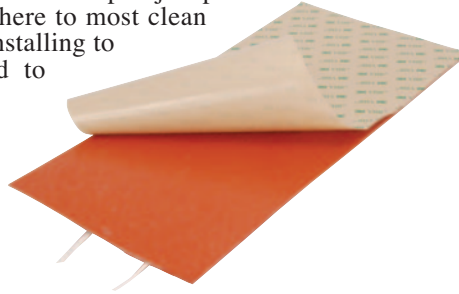

Note: To obtain the expected life of **Silicone Rubber** or **Kapton®** heaters, *care must be taken to mount correctly*. Regardless of the mounting technique used, do not trap any air under the heater; this can cause hot spots and possible premature heater failure. Use a rubber roller over the heater surface to assure good adhesion.

PSA Plus

A layer of aluminum foil is vulcanized to the back of the heater for added heat dissipation prior to the application of PSA.

Flexible Heater Factory Vulcanizing to Metal Component

Factory Vulcanizing

Flexible heaters can be factory vulcanized to bare or anodized aluminum, Stainless Steel, Marble, or other hard surfaces for permanent attachment and excellent heat transfer.

The uncured silicone rubber heater is placed on the metal part and placed in the vacuum oven where the heater vulcanizes and adheres to the part in one operation. This procedure forms an extremely strong permanent bond with most metals due to the fact that the silicone rubber flows into and fills the micro structure in the surface of the metal. The metal part can be manufactured by Tempco or supplied by the customer. Consult Tempco for other materials including granite.



Flexible Heater Magnetic Mounting

Magnetic Mounting

A flexible magnetic material can be attached to the back of a silicone rubber flexible heater. Will adhere to many varieties of steel. Ideal for those situations where you need to “Slap On” some heat! Specify when requesting a quote.

Maximum Temperature: 200°F / 93°C

Maximum Watt Density: 1 W/in² (0.16 W/cm²)

Maximum Width: 24" (610 mm)



Flexible Heater Field Applied Adhesive

Field Applied Adhesive

For a field applied permanent bond, a room temperature and ambient humidity curing silicone rubber adhesive is recommended. Tempco offers two types:

Both RTV106 and RTV116 will retain physical and electrical properties up to 500°F (260°C).

When using RTV adhesive, cover the heater completely with a thin layer of RTV, position the heater in place, and use a small roller to remove air bubbles, which could cause hot spots and lead to premature failure of the heater.

RTV106 — a red, paste consistency, high-temperature resistant adhesive sealant.

Part Number: **SEA-102-109** 10.1 ounces
Part Number: **SEA-102-105** 2.8 ounces

RTV116 — a red, pourable, high-temperature resistant adhesive sealant that will flow or self-level on a surface.

Part Number: **SEA-102-102** 9.5 ounces



Flexible Heater Mechanical Fasteners

Various techniques are routinely used when flexible heaters must be detachable from cylindrical parts. The mechanical fastener options include the following:



**Heavy Duty D-Rings
& 3-Layer Straps**



**Standard D-Rings
& 2-Layer Straps**



Velcro® Straps



Boot Hooks & Springs



Boot Hooks & Lacing Cord



Grommets & Lacing Cord

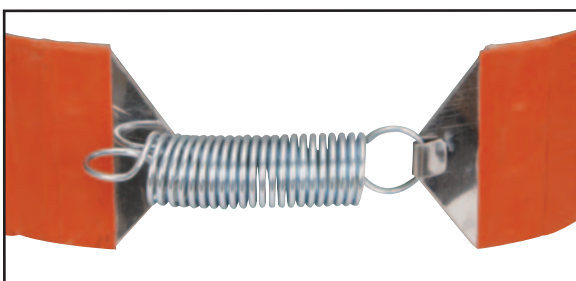

Heavy Duty Spring Clamps



Snaps

Consult Tempco for detailed specifications on the mechanical fasteners shown.

Flexible Heater Clamping

Clamping

Flexible heaters may be applied by clamping or compression between two rigid materials. The plate surfaces must be ground reasonably smooth. Care must be taken not to damage the heater or pierce the insulation. Mill out an area or cutout in the top plate for the added thickness of the lead exit area.

Recommended Maximum Pressure: 40 PSI

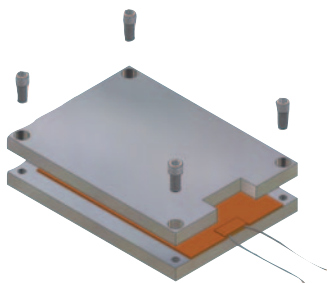

Note: For added durability, mill out the space for the heater to mount in the same thickness as the heater.

Mounting Methods

Outside Diameter Mounting

Tempco has developed the techniques necessary to permanently mount silicone rubber heaters to the outside diameters of pipes and medium size vessels. This technique is particularly useful for heated drums and air or gas heating.

Minimum Diameter: 0.5" (12.7 mm)

Maximum Diameter: 6" (152.4 mm)

Maximum Length: 20" (508.0 mm)

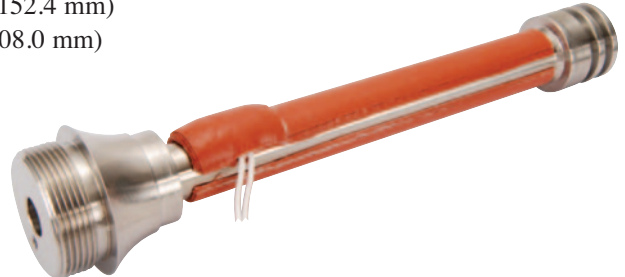
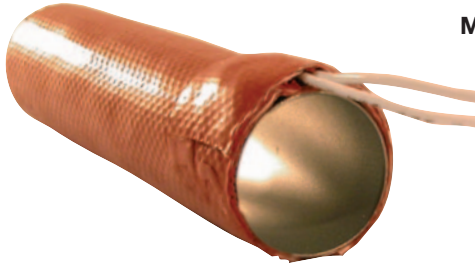

Flexible Heater Three-Dimensional Configurations

Dimensional silicone rubber heaters can be vulcanized to fit a shaped outline. This technique is particularly useful for wrapping Silicone Rubber heaters around pipes or small vessels. Custom tooling or special forms may be required.



7/8" Hexagon

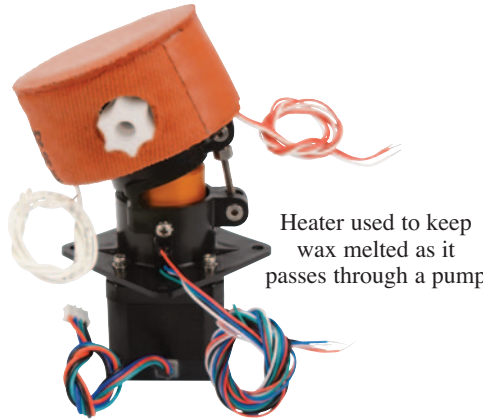

Heater used to keep wax melted as it passes through a pump

An insulating heater used on a compressor pump to prevent freezing in Siberia



One-Piece Y-Pipe Heater
(Shown on Pipe at left;
Shown flat below)



Heater used to remove condensation on a vacuum canister

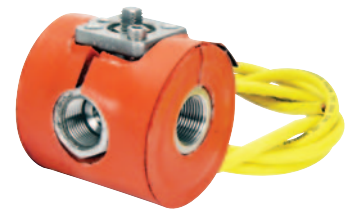

Heater manifold 3D formed for use on a snow making machine

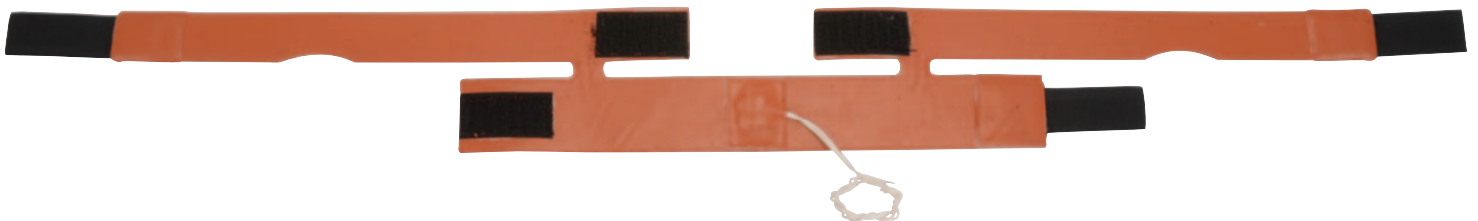

Flexible Heater Built-In Temperature Sensors

Temperature Sensors

Flexible surface heaters can be manufactured with temperature sensors of various types including thermocouples, RTDs, and thermistors. Thermal fuses can also be incorporated into the design to prevent dangerous temperatures in the event of a control device failure (see page 9-17).

The sensors can be mounted on the heater to sense the temperature of the part being heated or the heater surface temperature itself. For silicone rubber heaters, temperature sensors are mounted to the surface of the heater under a vulcanized patch. For Kapton® heaters the sensor is affixed to the surface with epoxy. The leads are run on the exterior of the heater to avoid heat and mechanical interference with the resistance element inside.

Tempco offers three types of sensor mounting:

Heater Sensing: The sensor is located over heater wiring to sense the temperature of the heater surface (standard).

Indirect Load Sensing: A cold section is designed into the resistance element layout for where the sensor is to be located.

Direct Load Sensing (silicone rubber only): A hole/window is cut into the bottom layer of the heater so that the sensor is mounted in the “window” under a vulcanized patch, allowing it to be in contact with the load. (Note: higher cost and subject to potential mechanical damage.)

Lead Wire Connectors

Tempco has the tooling to attach many different types of “quick connectors” that are used with sensors. Consult Tempco with your requirements.

Sensor Types

Thermocouples

Tempco can incorporate common Type J or K thermocouples almost anywhere on the heater surface. Other thermocouple types can also be used. Standard thermocouple temperature ranges apply. Specify when ordering. See page 14-90 for optional plugs.



Note: Standard length is 10". Specify sensor lead wire length and the distance from where the sensor leads exit the heater to the heater edge (Dimension X) when ordering.

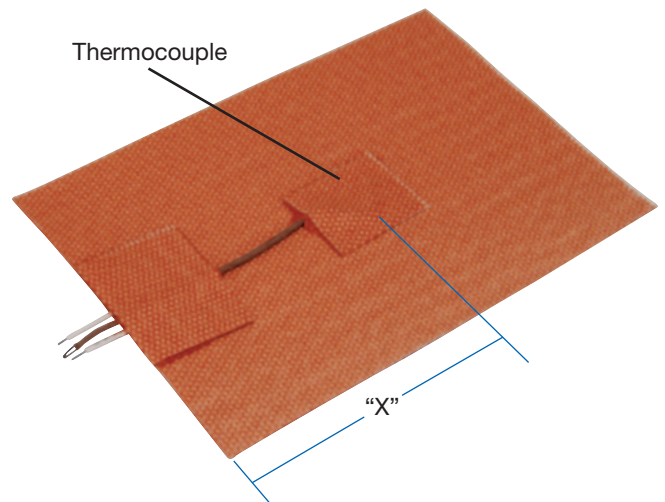

RTDs (2- or 3-wire)

The RTDs used are platinum thin film 100 ohm @ 100°C. The standard curve is 0.00385 TCR / DIN432760. Other common RTDs such as 1000 ohm can also be used. Specify when ordering.

The RTD's resistance increases with a rise in temperature and is considered the most accurate and stable sensor.

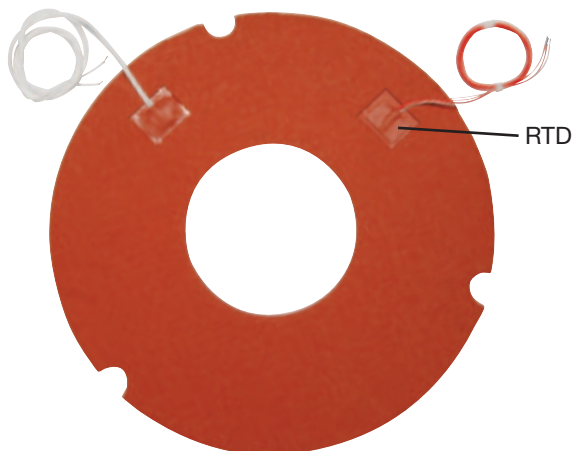

Thermistors

Thermistors are also a resistive-based temperature sensor. They do not generally respond in a linear style and are used in a limited temperature range or at a specific single temperature.

Small bead style thermistors can be mounted directly on the heater.

The thermistor's response is generally designed directly into the customer's electronic control system. Therefore if a thermistor is required, specify manufacturer, specific model number, type and specifications when requesting a quote. Consult Tempco for more information.

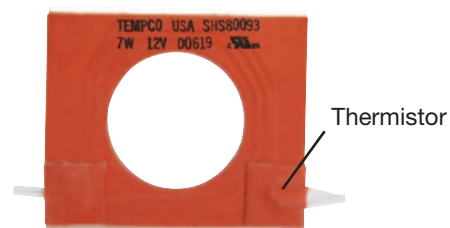

Flexible Heater Built-in Thermostats

Flexible Heater Pre-Set and Adjustable Built-In Thermostats

Pre-set thermostats provide a low-cost means of providing built-in control of surface heaters. The thermostat is normally wired directly into the heater. If the current draw of the heater exceeds the rating of the thermostat, the voltage is over 250V, has a Dual Voltage Design, or is 3-ph, separate leads on the thermostat will be supplied for use with a separate (remote) relay to control the heater (see pages 13-94, 95, 96).

The thermostats are normally mounted over a heated section to sense the heater's temperature or optionally over a cold section to indirectly sense the temperature of the load. The thermostat is enclosed in a molded silicone rubber housing and permanently attached to the heater.

Specify type and location when ordering.



Note: If heater amps exceed thermostat electrical ratings, separate leads will be provided for use with a relay (see pages 13-94 through 13-96).

Snap Action Thermostat – Automatic Reset

Quick cutout on rise to temperature. The contacts will open on rise when the temperature increases to the snap point of the calibrated bimetal disc.

Setpoint (opens): available from 50 to 450°F in 10°F increments
most thermostats close 20 to 30°F below setpoint (see page 13-82)

Electrical Ratings: 125 Vac, 15 Amp, 1875W
250 Vac, 10 Amp, 2500W

Minimum Heater Width: 1.312"

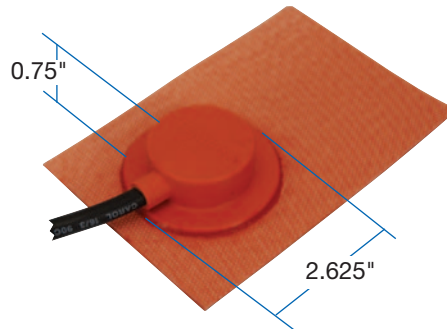
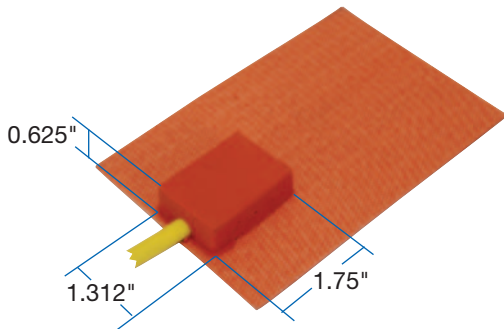
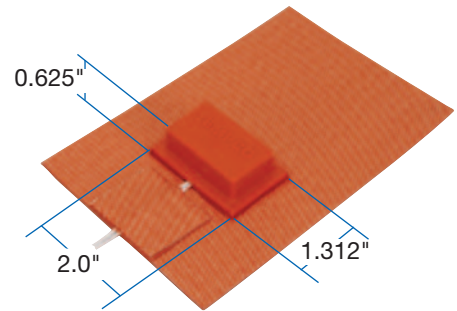

Adjustable Thermostat

Adjustable thermostats allow the user to dial-in a specific temperature and attain a desired result. The thermostat is enclosed in a molded silicone rubber housing and permanently attached to the heater. The adjustment shaft extends through a pre-formed hole. A high temperature knob is included.

Amps: 12.5A @ 125V, 6.5 A @ 250V

Watts: 1500W @ 120V, 1560W @ 240V

Adjustment Ranges Available:

- 50 to 425°F (10 to 218°C)
- 90 to 140°F (32 to 60°C)
- 100 to 190°F (38 to 88°C)
- 70 to 190°F (21 to 88°C)
- 50 to 160°F (10 to 71°C)
- 70 to 140°F (21 to 60°C)

Minimum Heater Width: 1.75" (44.5 mm)

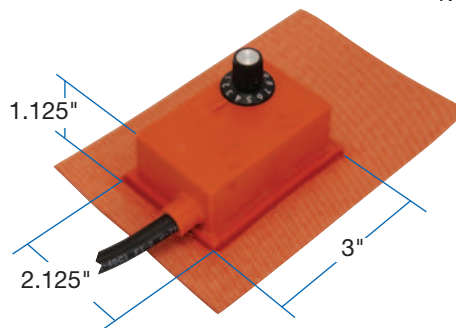
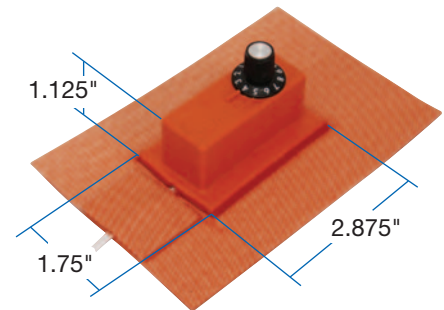

Flexible Heater Built-In Thermostats

Snap Action High Limit Thermostats – Manual Reset

A High Limit with a manual reset push button can also be designed in. Specify when requesting a quote.

NOTE: See page 13-83 for stock temperature ratings.



Creep Action Thermostat

Sustained response, and a slow cutout at the trip point. The creep action thermostat has a slow make/slow break action around setpoint.

Setpoint (opens): available in a limited selection from 50 to 300°F in 10°F increments. Consult Tempco.

Electrical Ratings: 120 Vac, 12 Amp, 1440W
240 Vac, 6 Amp, 1440W

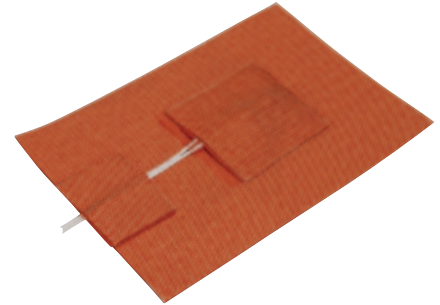

Flexible Heater Built-In Thermal Fusing

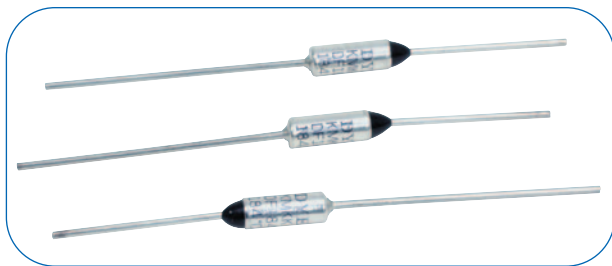

Temperature Range: 151 to 464°F (66 to 240°C)
Single temperature point only, in 10° to 20° steps. Consult Tempco with your requirements.

NOTE: See page 13-84 for stock thermal cutoff temperature ratings.

Thermal fuses / cutoffs are used as high limit protection devices to guard the object being heated from dangerous temperatures in the event of a primary control device failure.

The thermal fuse can be mounted using various methods depending on other options. If the heater does not have a thermostat, the thermal fuse would be mounted under the lead exit patch. If used in conjunction with a thermostat, it could be mounted under the thermostat cover.

Voltage: 120/240 Vac

Maximum Amperage: 10 Amps, continuous



Note: The thermal cutoff is a one-shot, non-resettable component.

PVC Pipe/Conduit Bending Heaters

Tempco's PVC Pipe/Conduit Bending Heater Assembly makes it easy to form PVC plastic pipe and conduit at the job site.

To bend the PVC pipe/conduit, just wrap the heater assembly around the pipe at the location desired and plug it in. In 4 to 18 minutes, depending on pipe size, it will be soft enough to bend by hand to the desired radius or shape.

This heavy-duty assembly, made from our proven wire-wound silicone rubber heater technology, will provide hundreds of hours of use.

Stock PVC Pipe Bending Heaters

Pipe Diameter	Length	Watts	Volts	Warm-Up Time	Part Number
1/2" to 1-1/2"	12"	180	120	4 – 10 minutes	SHS01210
2" to 4"	20"	950	120	7 – 18 minutes	SHS01222

Design Features

- * Built-in thermostat limits temperature to 194°F (90°C)
- * Standard Voltage is 120 Vac
- * 6-ft. plug and cordset standard

